



# Air Conditioning Clinic

---

## Refrigeration System Components

One of the Fundamental Series

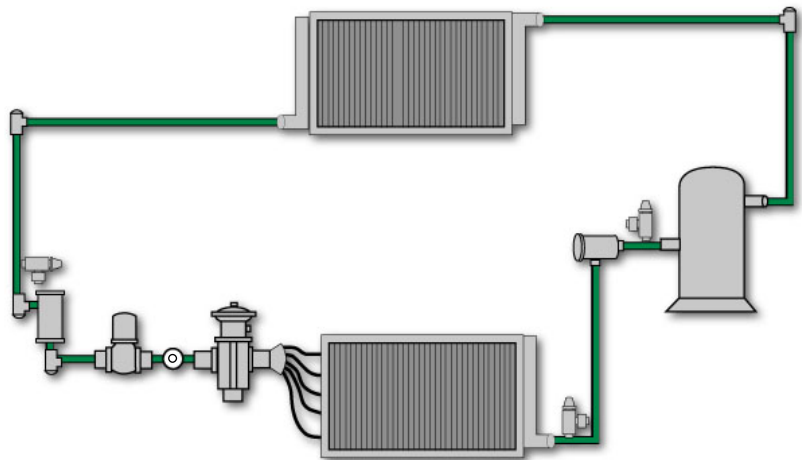

Perforation 0.75" from edge

# Comment Card

We want to ensure that our educational materials meet your ever-changing resource development needs. Please take a moment to comment on the effectiveness of this Air Conditioning Clinic.

## Refrigeration System Components

### One of the Fundamental Series

TRG-TRC005-EN

Level of detail (circle one)      Too basic                      Just right                      Too difficult

*Rate this clinic from 1-Needs Improvement to 10-Excellent...*

	1	2	3	4	5	6	7	8	9	10
Content										
Booklet usefulness										
Slides/illustrations										
Presenter's ability										
Training environment										

Other comments? \_\_\_\_\_  
 \_\_\_\_\_  
 \_\_\_\_\_

**About me ...** Type of business \_\_\_\_\_  
 Job function \_\_\_\_\_  
 Optional: name \_\_\_\_\_  
                   phone \_\_\_\_\_  
                   address \_\_\_\_\_

Give the completed card to the presenter or drop it in the mail. Thank you!



**TRANE**

*The Trane Company • Worldwide Applied Systems Group  
 3600 Pammel Creek Road • La Crosse, WI 54601-7599  
 www.trane.com  
 An American-Standard Company*

Perforation 5.5" from bottom/top

# Response Card

We offer a variety of HVAC-related educational materials and technical references, as well as software tools that simplify system design/analysis and equipment selection. To receive information about any of these items, just complete this postage-paid card and drop it in the mail.

- Education materials**     Air Conditioning Clinic series  
                                    Engineered Systems Clinic series  
                                    Trane Air Conditioning Manual  
                                    Trane Systems Manual
- Software tools**             Equipment Selection  
                                    System design & analysis
- Periodicals**                 Engineers Newsletter
- Other?**                       \_\_\_\_\_

**About me...**

Name \_\_\_\_\_  
 Title \_\_\_\_\_  
 Business type \_\_\_\_\_  
 Phone/fax \_\_\_\_\_  
 E-mail address \_\_\_\_\_  
 Company \_\_\_\_\_  
 Address \_\_\_\_\_  
 \_\_\_\_\_  
 \_\_\_\_\_

Thank you for your interest!



**TRANE**

*The Trane Company • Worldwide Applied Systems Group  
 3600 Pammel Creek Road • La Crosse, WI 54601-7599  
 www.trane.com  
 An American-Standard Company*

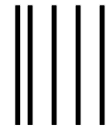

NO POSTAGE  
NECESSARY  
IF MAILED  
IN THE  
UNITED STATES

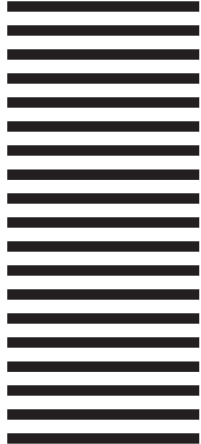

**BUSINESS REPLY MAIL**  
FIRST-CLASS MAIL      PERMIT NO. 11      LA CROSSE, WI

POSTAGE WILL BE PAID BY ADDRESSEE

**THE TRANE COMPANY**  
**Attn: Applications Engineering**  
**3600 Pammel Creek Road**  
**La Crosse WI 54601-9985**

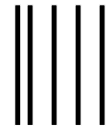

NO POSTAGE  
NECESSARY  
IF MAILED  
IN THE  
UNITED STATES

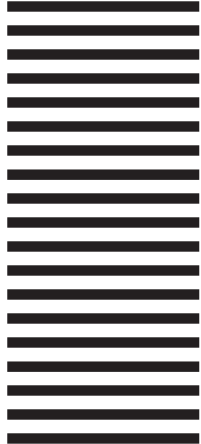

**BUSINESS REPLY MAIL**  
FIRST-CLASS MAIL      PERMIT NO. 11      LA CROSSE, WI

POSTAGE WILL BE PAID BY ADDRESSEE

**THE TRANE COMPANY**  
**Attn: Applications Engineering**  
**3600 Pammel Creek Road**  
**La Crosse WI 54601-9985**



Crop to width of 7.75"



---

# Refrigeration System Components

One of the Fundamental Series

**A publication of  
The Trane Company—  
Worldwide Applied Systems Group**

---

# Preface

---

## Refrigeration System Components

---

A Trane Air Conditioning Clinic

Figure 1

The Trane Company believes that it is incumbent on manufacturers to serve the industry by regularly disseminating information gathered through laboratory research, testing programs, and field experience.

The Trane Air Conditioning Clinic series is one means of knowledge-sharing. It is intended to acquaint a nontechnical audience with various fundamental aspects of heating, ventilating and air conditioning. We have taken special care to make the clinic as uncommercial and straightforward as possible. Illustrations of Trane products only appear in cases where they help convey the message contained in the accompanying text.

This particular clinic introduces the reader to the concept of vapor-compression **refrigeration system components**.

# Contents

---

	<b>Introduction</b> .....	1
period one	<b>Refrigeration Cycle</b> .....	2
period two	<b>Condensers</b> .....	5
	Air-Cooled Condensers .....	5
	Evaporative Condensers .....	7
	Water-Cooled Condensers .....	8
	Condenser Control .....	10
period three	<b>Evaporators</b> .....	16
	Finned-Tube Evaporators .....	16
	Shell-and-Tube Evaporators .....	19
	Evaporator Control .....	20
period four	<b>Expansion Devices</b> .....	26
period five	<b>Accessories</b> .....	34
	Solenoid Valve .....	34
	Liquid-Line Filter Drier .....	36
	Moisture-Indicating Sight Glass .....	38
	Suction Line Filter .....	39
	Hot Gas Muffler .....	40
	Shutoff Valve .....	41
	Access Port .....	42
period six	<b>Review</b> .....	43
	<b>Quiz</b> .....	48
	<b>Answers</b> .....	50
	<b>Glossary</b> .....	51



# Introduction

---

## notes

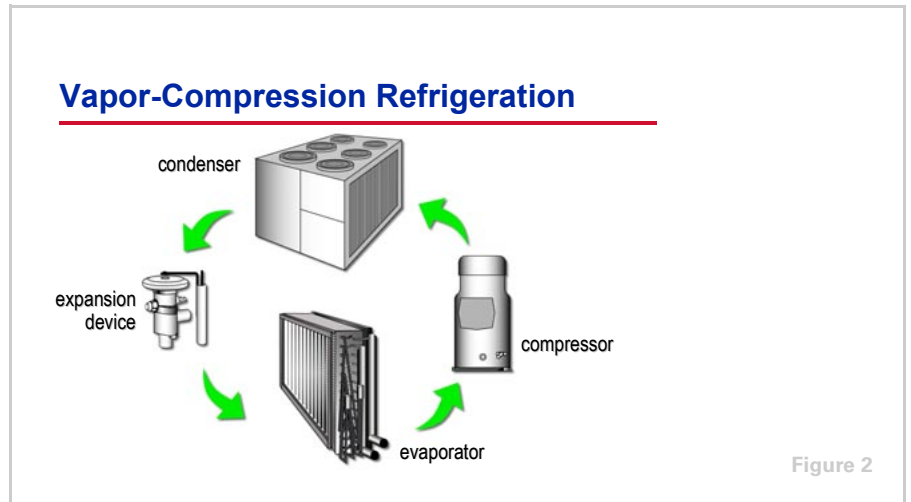

The major components of a vapor-compression refrigeration system include the compressor, condenser, expansion device, and evaporator. The latter three will be discussed in this clinic – the compressor is discussed in a separate clinic.

This clinic will also discuss many of the common accessories used in a comfort-cooling refrigeration system.



# period one

## Refrigeration Cycle

---

### notes

### Refrigeration System Components

---

*period one*

Refrigeration Cycle

Figure 3

First, a brief review of the vapor-compression refrigeration cycle will help to relate these components.

### Refrigeration Cycle

---

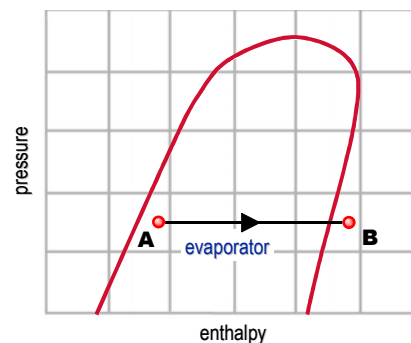

Figure 4

A diagram of a typical vapor-compression refrigeration cycle can be superimposed on a pressure-enthalpy (P-h) chart to demonstrate the function of each component in the system. The **pressure-enthalpy chart** plots the properties of a refrigerant – refrigerant pressure (vertical axis) versus enthalpy (horizontal axis). **Enthalpy** is a measure of the heat content, both sensible and latent, per pound [kg] of refrigerant.

The cycle starts with a cool, low-pressure mixture of liquid and vapor refrigerant entering the evaporator (**A**) where it absorbs heat from the relatively warm air, water, or other fluid that is being cooled. This transfer of heat boils the liquid refrigerant in the evaporator, and this superheated refrigerant vapor is drawn to the compressor (**B**).

period one  
**Refrigeration Cycle**

notes

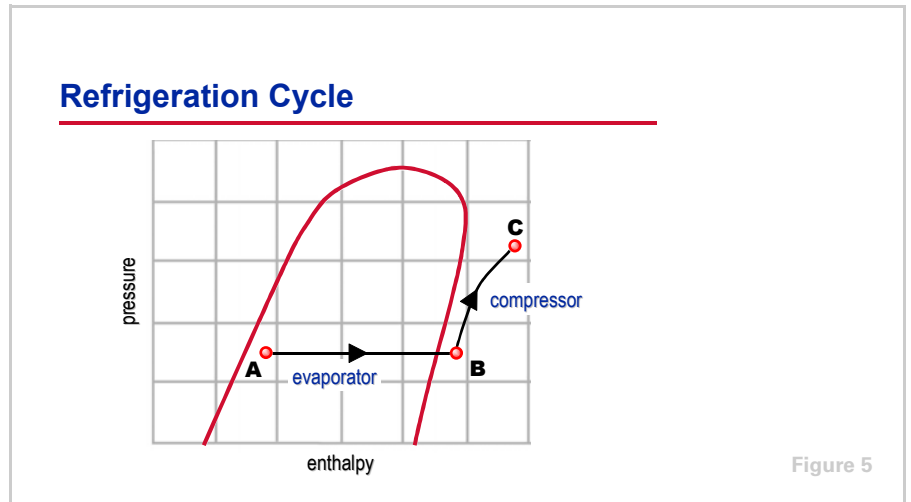

The compressor draws in the superheated refrigerant vapor (**B**) and compresses it to a pressure and temperature (**C**) high enough that it can reject heat to another fluid. This hot, high-pressure refrigerant vapor then travels to the condenser.

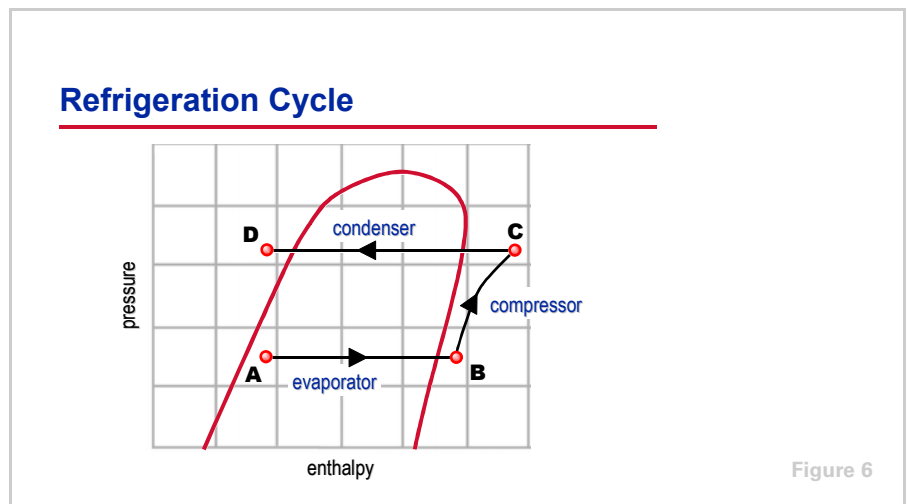

Within the condenser, heat is transferred from the hot refrigerant vapor to relatively cool ambient air or cooling water. This reduction in the heat content of the refrigerant vapor causes it to desuperheat, condense into liquid, and further subcool before leaving the condenser (**D**) for the expansion device.

period one  
**Refrigeration Cycle**

---

notes

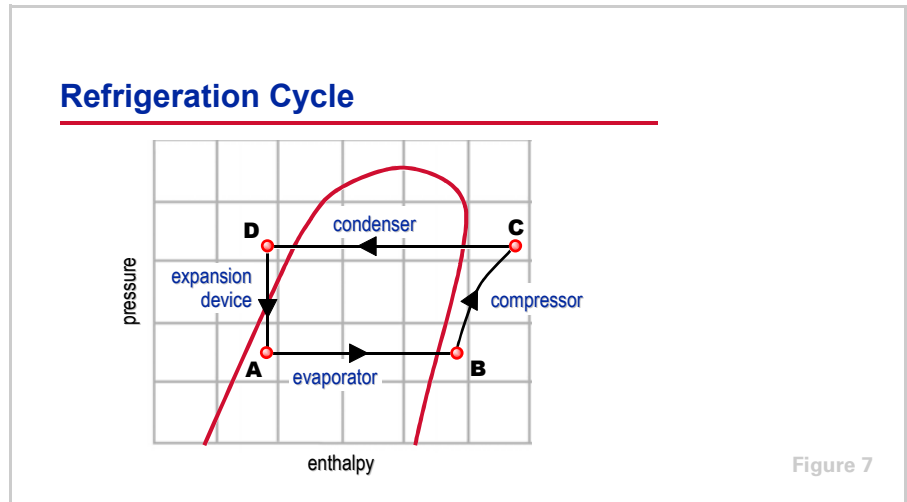

Finally, the high-pressure liquid refrigerant (**D**) flows through the expansion device, causing a large pressure drop that reduces the pressure of the refrigerant to that of the evaporator. This pressure reduction causes a small portion of the liquid to boil off, or flash, cooling the remaining refrigerant to the desired evaporator temperature.

The cooled mixture of liquid and vapor refrigerant then enters the evaporator (**A**) to repeat the cycle.

# period two

## Condensers

### notes

### Refrigeration System Components

*period two*  
**Condensers**

Figure 8

The first major component to be discussed is the condenser. The **condenser** is a heat exchanger that rejects heat from the refrigerant to air, water, or some other fluid.

The three common types of condensers are air-cooled, water-cooled, and evaporative.

### Air-Cooled Condenser

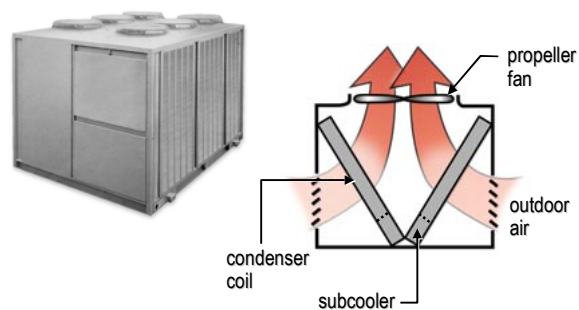

Figure 9

### Air-Cooled Condensers

A typical **air-cooled condenser** uses propeller-type fans to draw outdoor air over a finned-tube heat transfer surface. The temperature difference between the hot refrigerant vapor that is flowing through the tubes and the cooler outdoor air induces heat transfer. The resulting reduction in the heat content of the refrigerant vapor causes it to condense into liquid. Within the final few lengths of condenser tubing (the **subcooler**), the liquid refrigerant is further cooled below the temperature at which it was condensed.

## period two

# Condensers

### notes

The air-cooled condenser is very popular in both residential and commercial applications because of its convenience. It requires very little maintenance and does not require the freeze protection and water treatment that is necessary with a water-cooled condenser. Additionally, it is favored in areas that have an inadequate or costly water supply, or where the use of water for air conditioning is restricted.

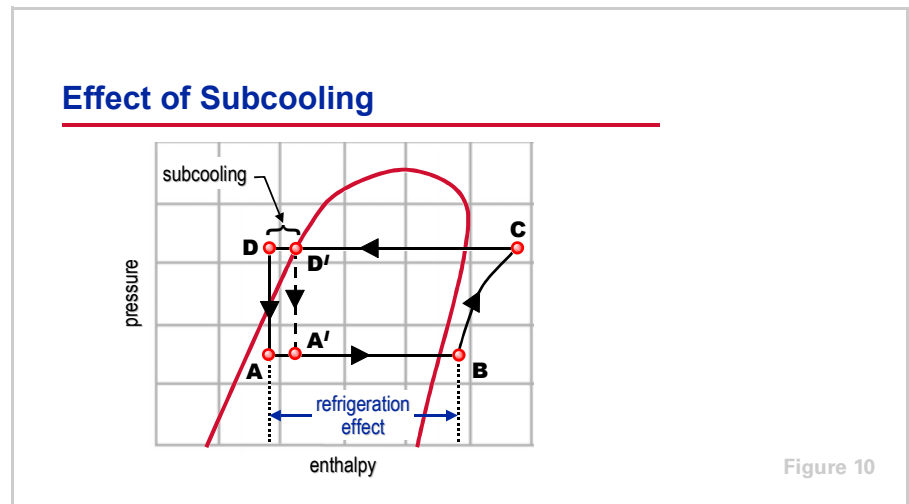

The benefit of subcooling on system performance can be demonstrated by comparing the performance of a system with and without subcooling.

The change in enthalpy (the line from **A** to **B**) that occurs in the evaporator is called the **refrigeration effect**. This is the amount of heat that each pound [kg] of liquid refrigerant will absorb when it evaporates.

In comparison, the same system without subcooling produces less refrigeration effect (the line from **A'** to **B**). The system without subcooling must evaporate substantially more refrigerant within a larger coil to produce the same capacity as the system with subcooling.

Instead of subcooling in the condenser, some packaged refrigeration equipment, such as water chillers, may use an economizer or liquid/vapor separator to increase this refrigeration effect.

## period two

# Condensers

## notes

### Centrifugal Fan Air-Cooled Condenser

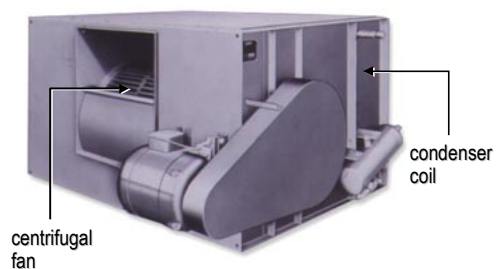

Figure 11

An alternative air-cooled condenser uses a centrifugal fan to draw or blow air over the condensing coil. The principal advantage of this design is that the centrifugal fan is capable of overcoming the higher static-pressure losses associated with ductwork. Therefore, if the condenser is to be located indoors and uses a duct system to deliver air to and from the condenser coil, the **centrifugal fan air-cooled condenser** is probably best suited for this application.

### Evaporative Condenser

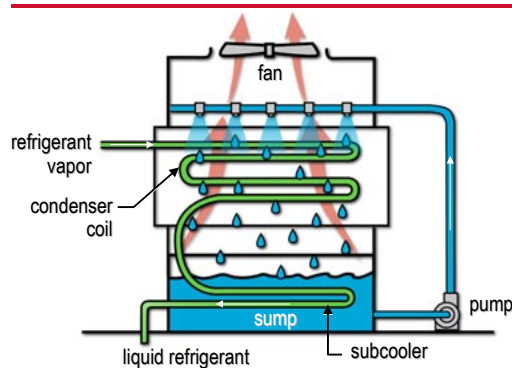

Figure 12

### **Evaporative Condensers**

A modification of the air-cooled condenser is the **evaporative condenser**. Within this device, the refrigerant flows through tubes and air is drawn or blown over the tubes by a fan. The difference is that water is sprayed on the tube surfaces. As the air passes over the coil, it causes a small portion of the water to evaporate. This evaporation process absorbs heat from the coil,

## period two

# Condensers

### notes

causing the refrigerant vapor within the tubes to condense. The remaining water then falls to the sump to be recirculated and used again.

Subcooling of the refrigerant can be accomplished by piping the condensed liquid back through another few rows of coil tubing, located either in the condenser airstream or in the water sump, where additional heat transfer reduces the temperature of the liquid refrigerant.

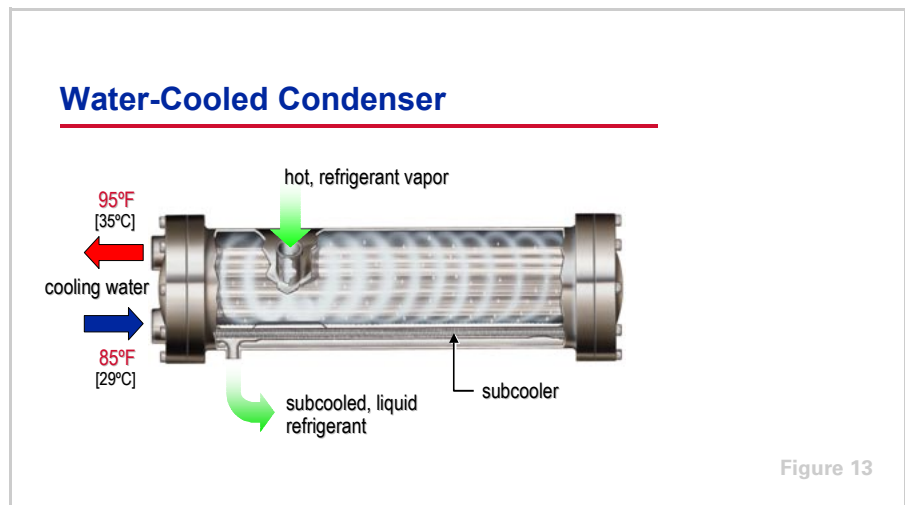

### Water-Cooled Condensers

The shell-and-tube is the most common type of **water-cooled condenser**. With this design, water is pumped through the tubes while the refrigerant vapor fills the shell space surrounding the tubes. As heat is transferred from the refrigerant to the water, the refrigerant vapor condenses on the tube surfaces. The condensed liquid refrigerant then falls to the bottom of the shell, where it flows through an enclosure that contains additional tubes (the subcooler). More heat is transferred from the liquid refrigerant to the water inside these tubes, subcooling the refrigerant.

After the warm water leaves the condenser, it must either be disposed of (as in the case of using water from a well) or it must be cooled before it can be reused by the condenser. In this example, the condenser brings in 85°F [29°C] water and warms it up to 95°F [35°C]. Before this water can be used again, it must be cooled back down to 85°F [29°C].

## period two

# Condensers

## notes

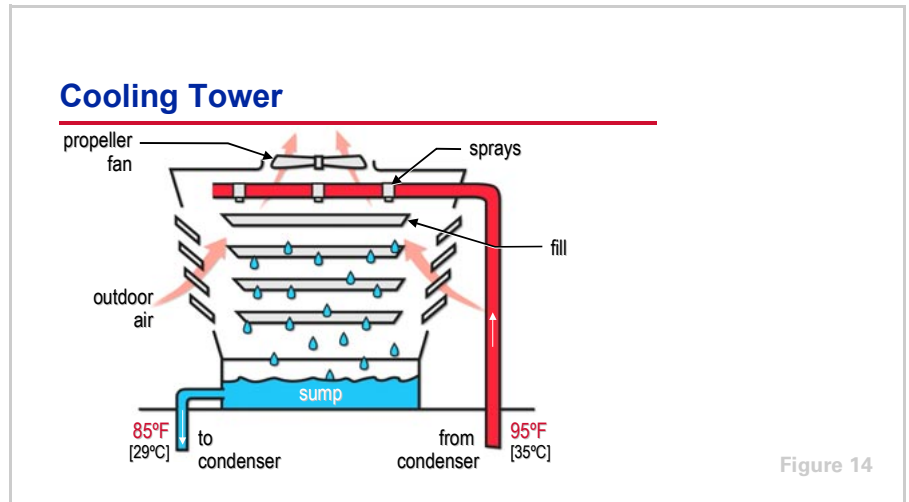

A **cooling tower** is a device commonly used to cool condensing water. In this design, warm water is sprayed over the fill inside the cooling tower while a propeller fan draws outdoor air upward through the fill. The movement of air through the spray causes some of the water to evaporate, a process that cools the remaining water. This cooled water then falls to the tower sump to be returned to the condenser.

The final temperature of the water leaving the tower is determined, in part, by the humidity of the outdoor air. If the outdoor air is dry, the final water temperature can be considerably lower than the ambient dry-bulb temperature. If the outdoor air is humid, however, the final temperature will be near the ambient dry-bulb temperature.

While a cooling tower can reclaim much of the condensing water, it cannot reclaim it all. The evaporation process uses up water to dissipate heat contributed by the cooling load plus the heat of compression. In addition, as the water evaporates, the dissolved minerals and water treatment chemicals become concentrated in the sump. To prevent this solution from becoming concentrated and possibly corrosive, water is periodically bled from the sump and an equal amount of fresh water is added.

In the past, some water-cooled condensers used water from either a municipal or a natural water supply as the condensing water. After rejecting the condenser heat to this water, it was dumped into the sewer or back into the body of water. Environmental and economic restrictions have made this method uncommon.

Finally, a geothermal well system can be used to reject the heat from the condenser by circulating the condensing water through a series of underground pipes. This method takes advantage of the naturally-cool ground temperatures.



## period two

# Condensers

## notes

### Condenser Control

- **Condenser capacity is influenced by:**
  - ◆ Temperature difference between refrigerant and cooling media
  - ◆ Flow rate of cooling media through condenser
  - ◆ Flow rate of refrigerant through condenser

Figure 15

### Condenser Control

The heat rejection capacity of a condenser is influenced by (1) the temperature difference between the refrigerant and the cooling media (air, water, or other fluid), (2) the flow rate of the cooling media through the condenser, and (3) the flow rate of the refrigerant through the condenser.

To balance the rate of heat rejection (in the condenser) with the changing system load, at least one of these variables may be controlled.

### Condenser Capacity

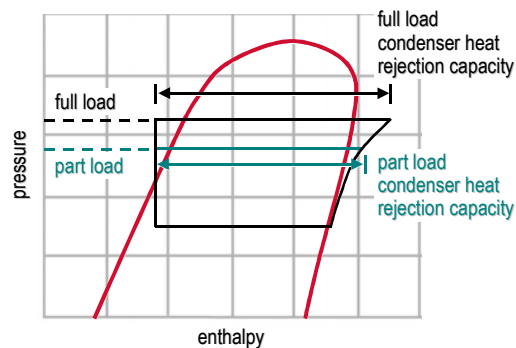

Figure 16

As the system load decreases, the heat rejection capacity of the condenser is greater than the load. Because of this excess capacity, the condenser matches the decreasing load by operating at progressively lower pressures. Additionally, a reduction in outdoor air temperature allows the temperature of the air or water flowing through the condenser to drop. This also has the effect of lowering the condensing pressure.

## period two

# Condensers

## notes

A reduction in condensing pressure lessens the power required to compress the refrigerant. Unfortunately, if the condensing pressure falls too low, the expansion valve may not be able to produce the flow of liquid refrigerant needed to satisfy the demand at the evaporator. In some systems, as the condensing pressure drops, the compressor suction pressure also drops, resulting in evaporator frosting and possible compressor shutdown due to a low-pressure safety device.

While it is not essential to control condensing pressure to a constant value, provisions should be made to control it within acceptable limits.

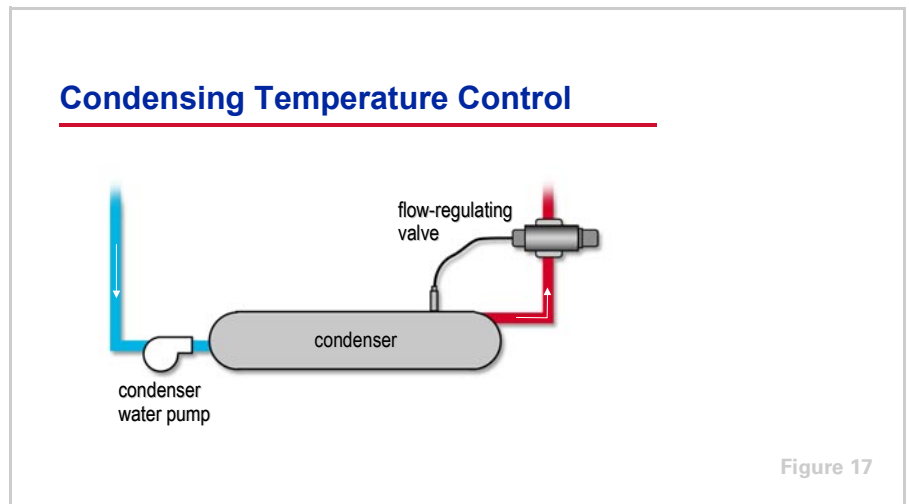

One common method of controlling the capacity of a water-cooled condenser is to vary the rate at which water flows through the condenser.

For example, assume a water-cooled condenser is piped to a municipal water system. To control the capacity of the condenser, a flow-regulating valve is installed on the leaving-water side of the condenser. As the load on the system decreases, the regulating valve senses the lowering condensing pressure. The valve reduces the flow rate of the water until the heat-rejection rate of the condenser balances the system load at an acceptable pressure and temperature.

## period two

# Condensers

### notes

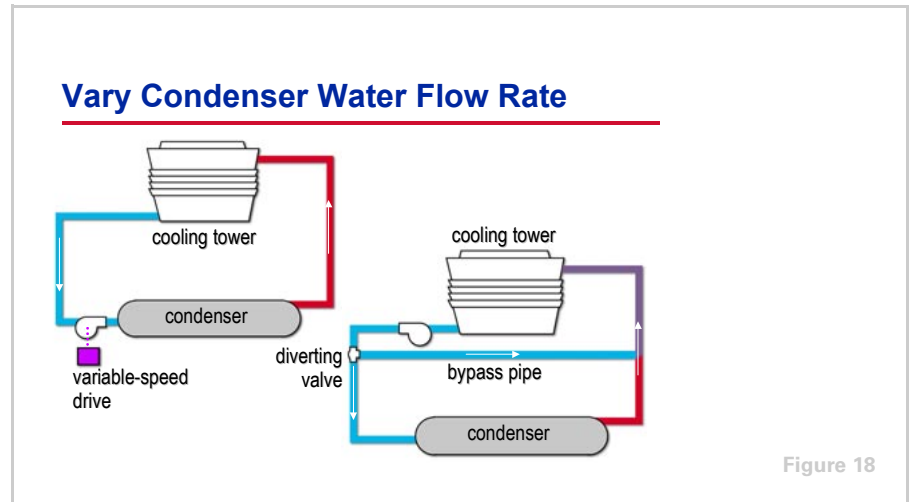

It is more common, however, for a water-cooled condenser to be connected to a cooling tower.

In this case, typical methods for modulating the water flow through the condenser include either using a variable-speed drive on the condenser water pump or using a diverting valve and pipe to bypass the condenser. The variable-speed drive on the pump modulates the amount of water pumped through the condenser. The diverting valve modulates the water flow through the condenser bundle by diverting some of the cooling water around the condenser through the bypass pipe, directly back to the cooling tower.

Each of these options has the effect of varying the flow rate of water through the condenser, ensuring an acceptable condensing pressure and temperature.

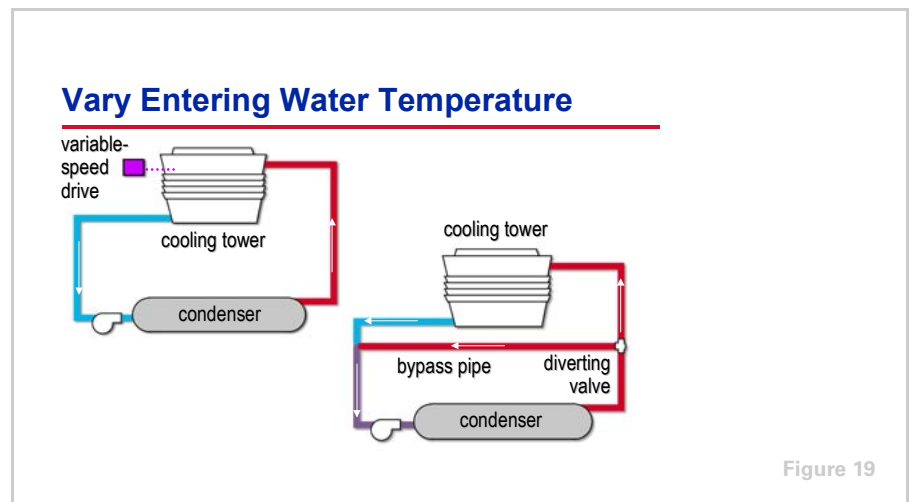

Another method of controlling the capacity of a water-cooled condenser is to vary the temperature of the water entering the condenser.

## period two

# Condensers

### notes

Common methods of modulating this water temperature include controlling the cooling tower fans or using a cooling-tower bypass pipe. Controlling the cooling tower fans, either by cycling fans on and off or by using a variable-speed drive on the fans, allows the system to control the temperature of the water leaving the tower sump. The diverting valve on the cooling-tower bypass pipe diverts warmer water leaving the condenser and mixes it with cooler water from the cooling tower to modulate the temperature of the water entering the condenser.

Each of these options has the effect of varying the temperature of the water entering the condenser, ensuring an acceptable condensing pressure and temperature.

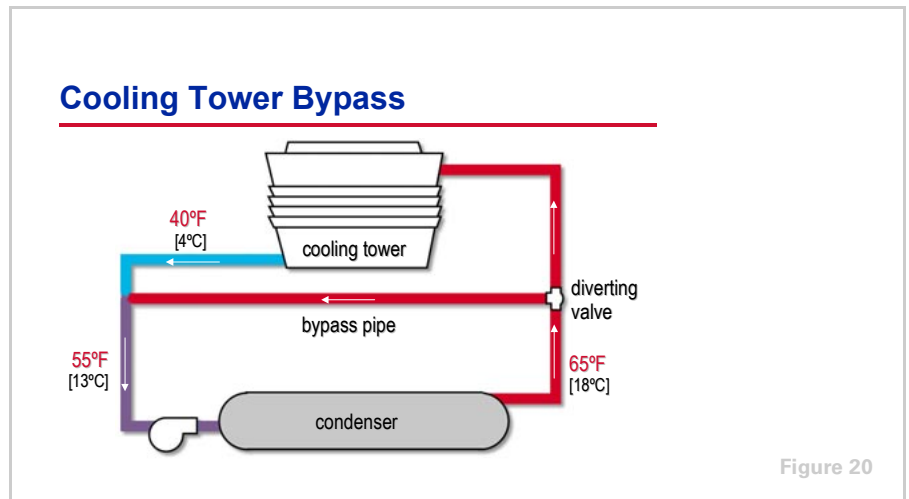

Another example is a system that must start and operate during cooler weather. The cold tower water would force the condensing pressure down to the point where the system could not operate. In this example, the temperature of the water entering the condenser is controlled by a diverting valve and a cooling-tower bypass pipe.

If the entering water temperature causes the condensing pressure to become too low, the valve begins to divert the warm water that is leaving the condenser and mixes it with the cool tower water, producing a controlled water temperature entering the condenser. In this example, by diverting 65°F [18°C] water leaving the condenser and mixing it with the 40°F [4°C] tower water, the condenser is provided with 55°F [13°C] condensing water. This warmer condensing water results in a higher condensing pressure.

## period two

# Condensers

### notes

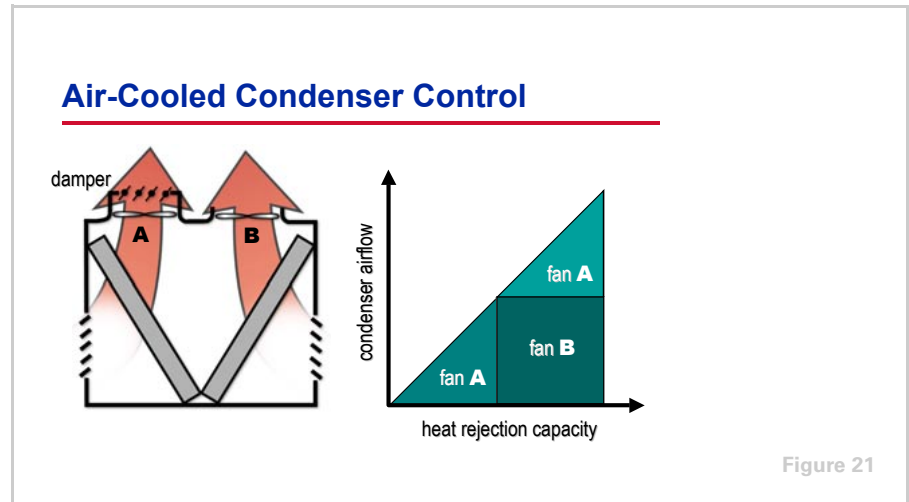

A common method of controlling the capacity of an air-cooled condenser is to vary the airflow across the condenser coil. The heat-rejection rate of a multiple-fan condenser is often controlled by cycling fans on and off to maintain acceptable condensing pressures. Alternatively, the airflow across the coil can be varied by using a damper or a variable-speed drive on one or more of the fans.

In this example, a damper has been added to one of the two condenser fans. Capacity control is accomplished by cycling fan **B** on and off while varying the airflow of fan **A** by modulating the damper. Both the damper and the cycled fan are controlled by condensing pressure. As the heat-rejection requirement increases, fan **A** continues to open its damper farther to increase its airflow. When fan **A** reaches full airflow, fan **B** turns on and fan **A** modulates its damper to continue to match the desired heat rejection rate.

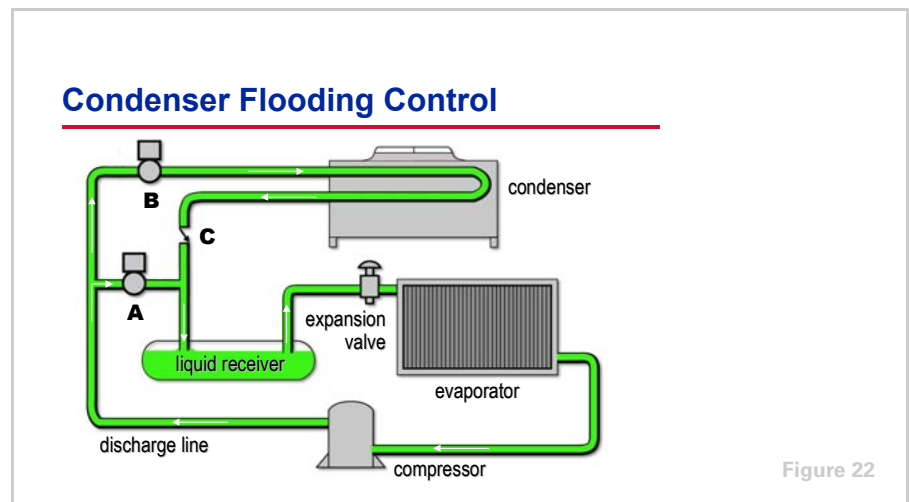

Another, less common method of controlling the capacity of an air-cooled

## period two

# Condensers

---

### notes

condenser is to flood the condenser coil with liquid refrigerant. A condenser coil tube that is filled with liquid refrigerant no longer acts as a condensing surface. Progressive flooding of the condenser coil tubes reduces the capacity of the condenser and raises the condensing pressure.

During normal, warm ambient conditions, valves **B** and **C** are open and valve **A** is closed. Assume that the system load is falling and, at the same time, the outdoor air temperatures has fallen to the point where the rate of heat rejection from the condenser balances the load at a condensing pressure less than desired. This minimum condensing pressure is the set point for valve **A**. As the condensing pressure decreases, so does the pressure in the discharge line. Valve **B** acts as a pressure regulator, and when the discharge-line pressure falls below its set point, valve **B** closes.

This causes the condensing pressure to drop farther. Sensing this reduction in condensing pressure, valve **A** opens and directs hot, high-pressure refrigerant vapor into the receiver. This increases the pressure in the receiver, controlling it to the desired condensing pressure. Because the pressure in the receiver is now higher than the pressure in the condenser, the check valve **C** does not allow the refrigerant to flow back into the condenser.

With valve **B** closed and valve **A** modulating to maintain the pressure in the receiver, the pressure in the discharge line begins to increase. When it exceeds the set point for valve **B**, the valve opens and again allows hot refrigerant vapor into the condenser. However, since the condensing pressure is still below the pressure in the receiver, the refrigerant cannot flow through valve **C**. This causes the condensed liquid to remain in the condenser, where it backs up, or floods, the condenser tubes.

The flooding of tubes causes the condenser to progressively lose capacity. When it has flooded enough that its capacity is reduced to the point where the condensing pressure rises above the pressure in the receiver, the higher-pressure condensed liquid will flow through check valve **C** into the receiver. This increases the pressure in the receiver above the minimum condensing pressure set point, closing valve **A**.

Condenser coil flooding provides the capacity modulation range needed to produce acceptable condensing pressures at reduced loads and correspondingly-low outdoor temperatures.

## period three

# Evaporators

### notes

### Refrigeration System Components

*period three*  
**Evaporators**

Figure 23

The second major component to be discussed is the **evaporator**. The evaporator is a heat exchanger that transfers heat from air, water, or some other fluid to the cool liquid refrigerant.

Two common types of evaporators are the finned-tube and the shell-and-tube.

### Finned-Tube Evaporator

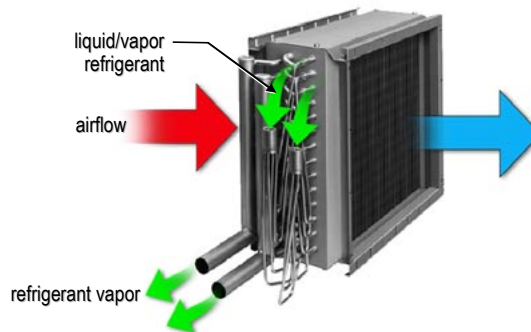

Figure 24

### Finned-Tube Evaporators

A **finned-tube evaporator** includes rows of tubes passing through sheets of formed fins. Cool, liquid refrigerant flows through the tubes, cooling the tube and fin surfaces. As air passes through the coil and comes into contact with the cold fin surfaces, heat is transferred from the air to the refrigerant. This heat transfer causes the refrigerant to boil and leave the evaporator as vapor.

## period three

# Evaporators

## notes

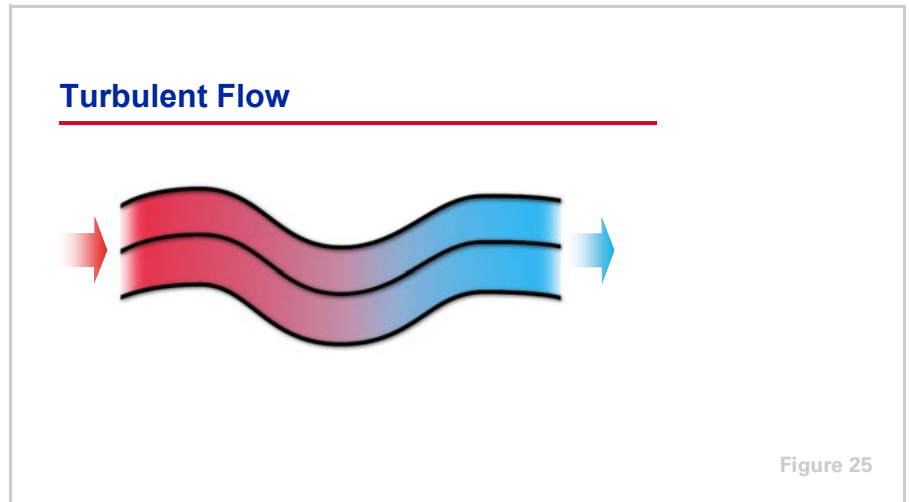

The fins of the coil are formed to produce turbulence as the air passes through them. This turbulence enhances heat transfer, preventing stratification within the coil-leaving airstream.

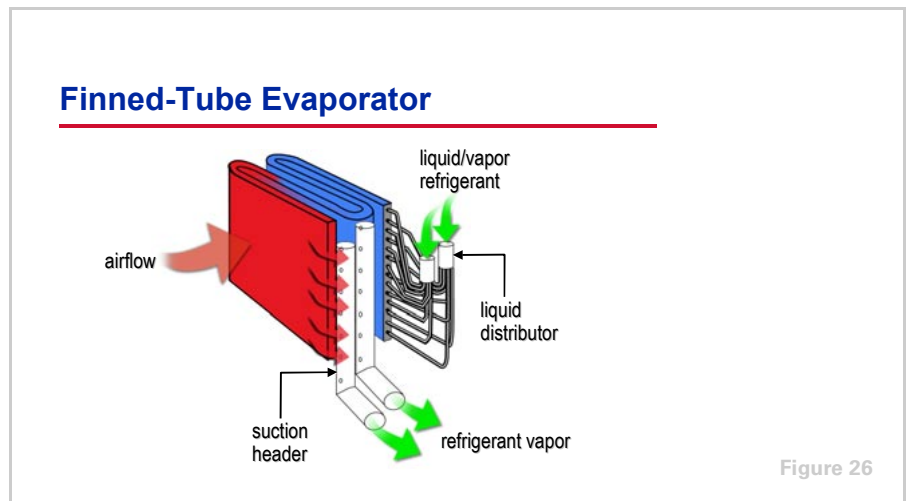

To provide uniform heat transfer throughout the coil, the liquid refrigerant is distributed to the coil tubes in several parallel circuits. A **distributor** is used to ensure uniform refrigerant distribution through these multiple coil circuits. It distributes the liquid/vapor refrigerant mixture to the coil through several tubes of equal length and diameter.

As the refrigerant passes through the tubes of the coil, the liquid refrigerant absorbs heat from the air, causing it to boil off into vapor. The refrigerant vapor leaves the coil tubes and collects in a **suction header**.



## period three

# Evaporators

### notes

Each distributor has an allowable range of refrigerant flow rates that define its stable operating range. As the size of the evaporator coil increases, it may be necessary to use more than one distributor to feed liquid refrigerant to the coil.

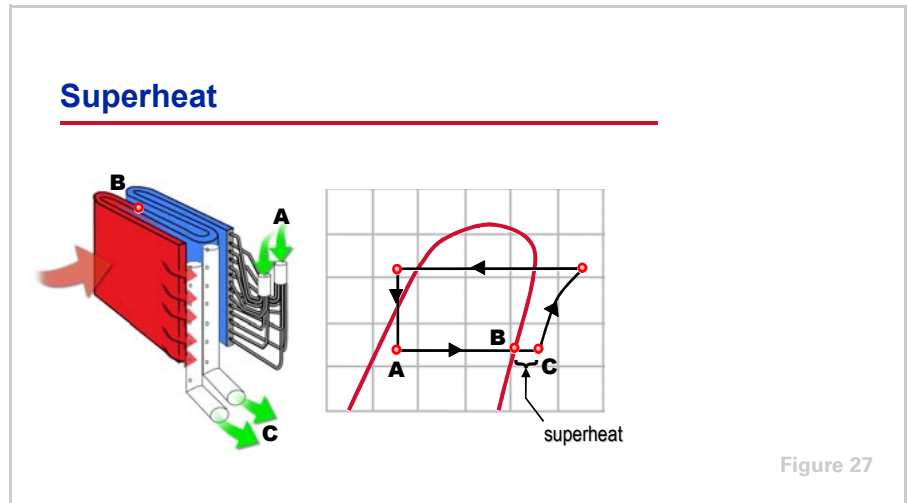

Inside the final length of tubes the location where the temperature difference between the refrigerant and the air is highest this larger temperature difference accelerates the rate of heat transfer and the refrigerant vapor absorbs even more heat. When the liquid refrigerant has completely evaporated, this additional heat gain to the vapor is called **superheating**.

Superheating the refrigerant vapor (the line from **B** to **C**) shifts it away from the liquid/vapor region and ensures that the refrigerant vapor is completely free of liquid prior to traveling to the compressor.

## period three

# Evaporators

## notes

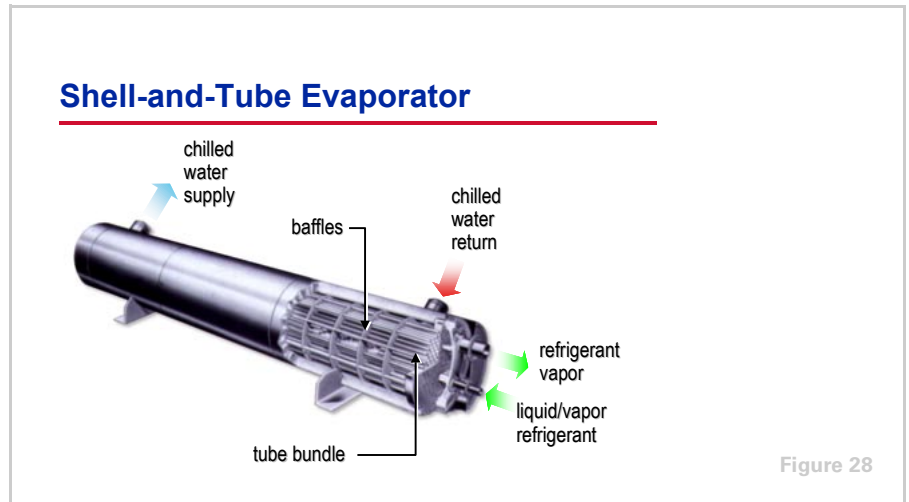

### Shell-and-Tube Evaporators

Instead of producing cooled air, a **shell-and-tube evaporator** is used to produce chilled water. In this type of evaporator, the cool liquid refrigerant flows through the tubes and water fills the shell space surrounding the tubes. As heat is transferred from the water to the refrigerant, the refrigerant boils inside the tubes and the resulting vapor is drawn to the compressor. Water enters the shell at one end and leaves at the opposite end.

This chilled water is pumped to one or more heat exchangers to handle the system cooling load. These heat exchangers could be coils used to cool air or they could be some other load that requires chilled water.

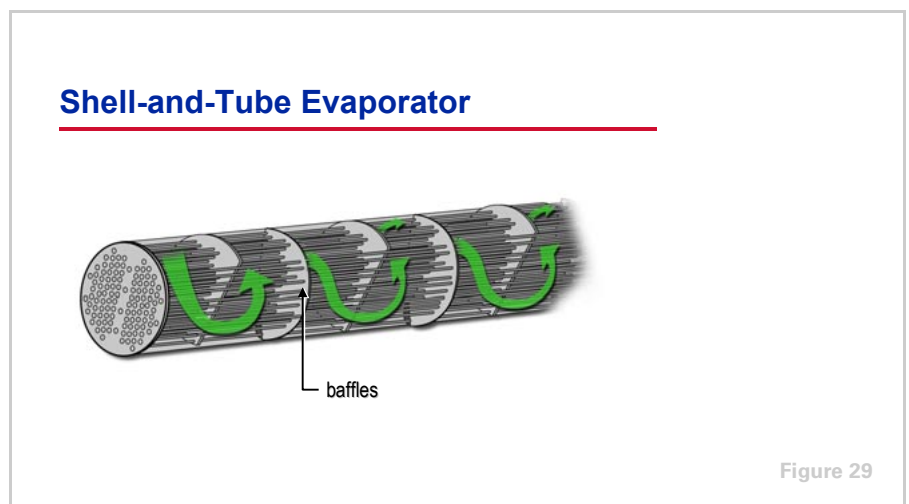

Baffles within the shell direct the water in a rising and falling flow path over the tubes that carry the refrigerant. This results in turbulence that improves heat transfer.

## period three

# Evaporators

---

## notes

### Evaporator Control

---

- **Evaporator capacity is influenced by:**
  - ◆ Temperature difference between refrigerant and air or water being cooled
  - ◆ Flow rate of air or water through evaporator
  - ◆ Flow rate of refrigerant through evaporator

Figure 30

### Evaporator Control

The rate of heat exchange within an evaporator is governed by (1) the temperature difference between the refrigerant and the air or water being cooled, (2) the flow rate of the air or water through the evaporator, and (3) the flow rate of the refrigerant through the evaporator.

In comfort-cooling applications, it is necessary to balance the capacity of the system with the ever-changing load. The flow rate and temperature of the air or water being cooled are typically controlled to respond directly to the system load. A constant-volume system delivers a constant quantity of air to the space and, to maintain the required space temperature at all load conditions, varies the temperature of this air. In contrast, a variable-air-volume (VAV) system delivers air at a constant temperature and varies the airflow to maintain the required space temperature at all load conditions.

These are variables that the evaporator must respond to rather than directly control. The most common method of controlling the capacity of the evaporator at part load is to control the temperature and/or flow rate of the refrigerant through the system by unloading or cycling compressors. To provide stable part-load operation and balance compressor unloading with the capacity of the evaporator, some direct form of evaporator capacity control may also be required.

## period three

# Evaporators

## notes

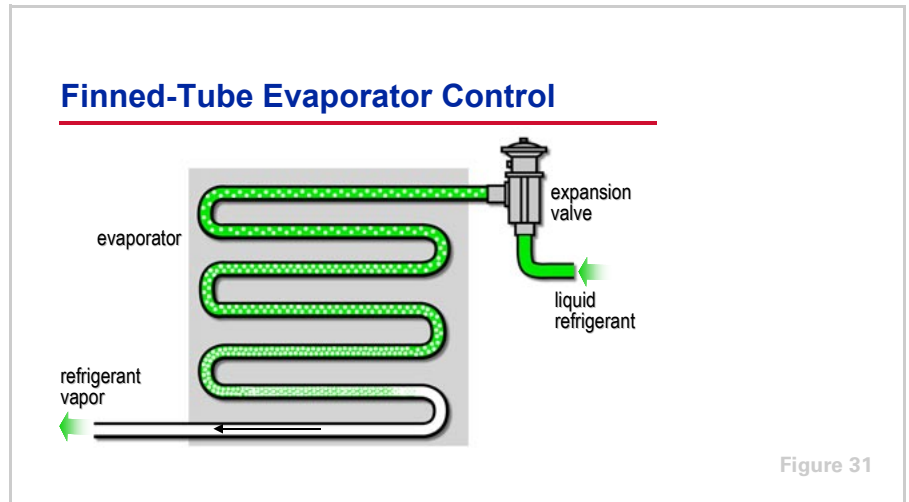

Typically, an expansion valve is used to control the flow rate of refrigerant through the evaporator to maintain the proper amount of superheat, ensuring that the liquid refrigerant will be completely vaporized. Working in conjunction with the unloading or cycling compressors, the expansion valve allows the evaporator capacity to match the system load. The operation of the expansion valve will be discussed further in Period Four.

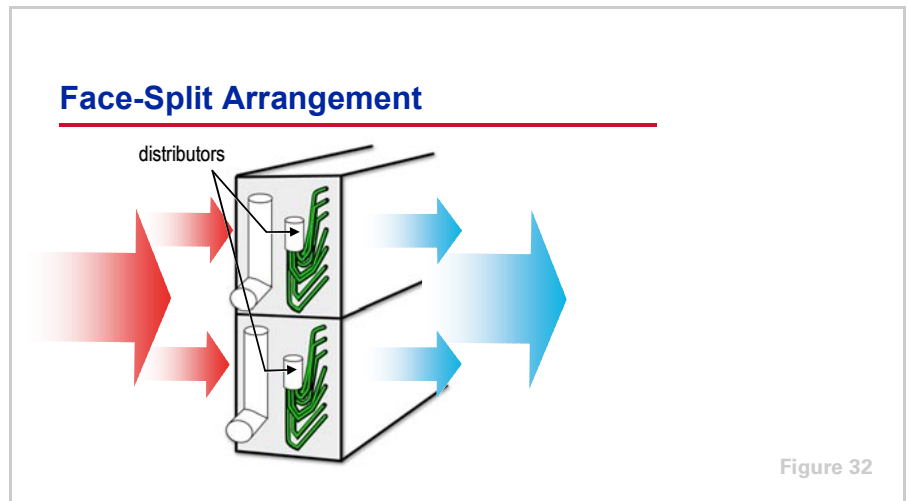

When an evaporator contains more than one liquid-refrigerant distributor, it is split into independently-controlled sections, each being served by its own expansion valve. By turning on and shutting off these coil sections, the evaporator can further control its capacity to better match the system load.

The three common arrangements for splitting finned-tube evaporator coils include: face-split, intertwined, and row-split.

## period three

# Evaporators

### notes

The **face-split** coil configuration, also called horizontal-split or parallel-flow, is split into parallel sections. A portion of the air passes through the top section, the remainder passes through the bottom section, and the two airstreams mix downstream of the coil.

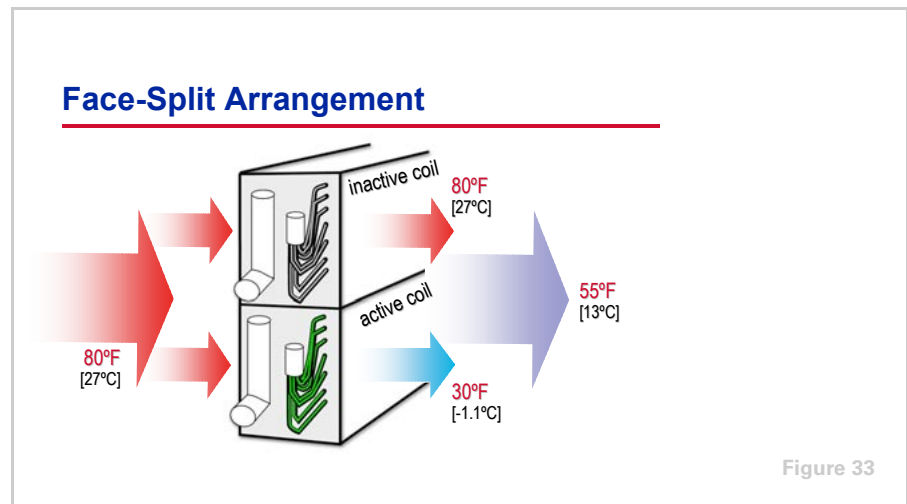

At lower loads, only one section of the face-split coil is active. A portion of the air passes through the active lower section and is cooled, while the rest of the air passes through the inactive top section and remains unconditioned. The two airstreams mix downstream of the coil, producing average temperature and humidity conditions. At higher loads, both sections of the coil are activated, providing a more uniform leaving-air temperature.

In a VAV application, where the leaving air is controlled to a constant temperature, the active section of coil must supply colder air than the desired average temperature at part load. Consequently, the refrigerant must get colder at part load, eventually reaching a condition where the coil surface is cold enough that the water condensing from the air will create frost on the coil. Resetting the supply air temperature upward can help to avoid this problem, but this may result in space humidity problems.

In constant-volume applications, where the leaving-air temperature varies to respond to changing loads, this is not as much of a concern since the average mixed temperature rises at part-load conditions. Therefore, face-split coils are well suited for constant-volume applications. They provide better part-load humidity control than could be obtained from a large coil controlled by a single expansion valve. In a constant-volume application, the lower section of a face-split coil should be activated first and deactivated last. This sequence prevents moisture that has condensed from the air flowing through the active coil section from flowing over the fins of the inactive coil section, where it could carry over into the supply airstream.

## period three

# Evaporators

## notes

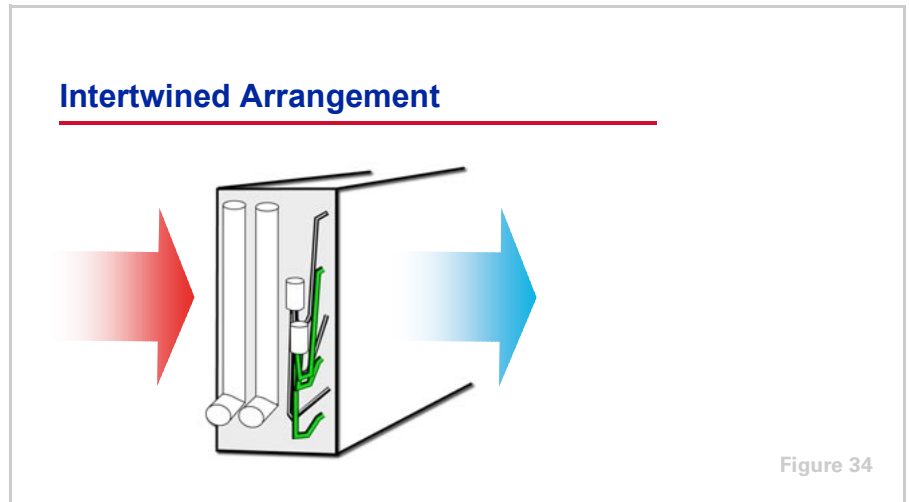

The **intertwined** coil configuration splits the coil sections by alternating the tubes fed in each row between two distributors.

At lower loads, liquid refrigerant is fed to every other tube of the coil and, therefore, it behaves like a coil with substantially greater fin surface. At higher loads, refrigerant is fed to all of the tubes in the coil.

Because of the increased fin surface available at part-load conditions, the coil surface does not have to be as cold to provide a constant leaving-air temperature. This reduces the potential for coil frosting. Therefore, intertwined coils are better suited for VAV applications.

Part-load humidity control is less of an issue with VAV applications due to the constant, cold leaving-air temperature. In constant-volume applications, intertwined coils provide good part-load humidity control, although potentially not as good as face-split coils.

## period three

# Evaporators

### notes

#### Row-Split Arrangement

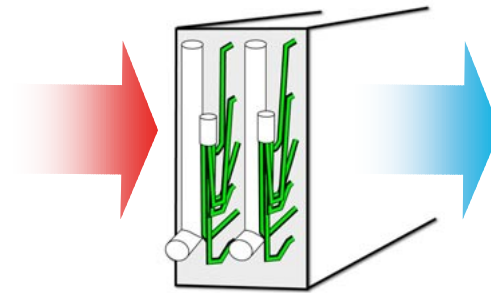

Figure 35

Finally, the **row-split** coil configuration, also called vertical-split or series-flow, places the independently-controlled coil sections in series in the airstream. All of the air passes through both coil sections, one before the other.

Typically, the first few upstream rows of the coil are served by one distributor, and the remaining downstream rows by another distributor. At lower loads, only the downstream section is active. At higher loads, the full depth of the coil is active.

#### Row-Split Arrangement

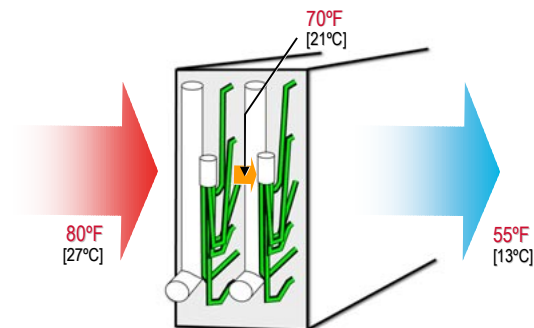

Figure 36

Row-split coils are very difficult to split into equal-capacity sections. Since the air entering the downstream section of coil has already been cooled somewhat by the upstream section of coil, the air-to-refrigerant temperature difference is much smaller. Therefore, the downstream section of coil requires more rows of tubes to deliver about the same capacity as the upstream section of coil. A common row-split arrangement uses two rows for the upstream section and

## period three

# Evaporators

## notes

four rows for the downstream section. This is an attempt to ensure near-equal loading of the two coil sections when both are active.

A second concern involves the control of superheat. The cooler temperatures leaving the upstream section of coil hamper the ability of the downstream section of coil to provide adequate superheat.

Row-split coils are generally not recommended for comfort-cooling applications. When applied, they require careful coil selection, expansion valve sizing and selection, and control.

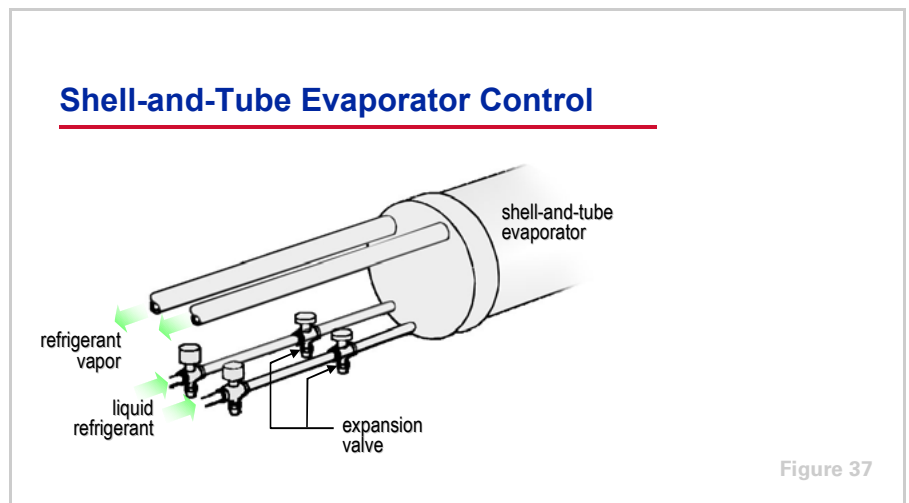

The capacity of a shell-and-tube evaporator is primarily controlled by the unloading or cycling of compressors. However, as with a finned-tube evaporator, it also uses an expansion valve to control the flow rate of refrigerant through the evaporator and ensure the proper amount of superheat in the system.

A shell-and-tube evaporator may also contain more than one liquid refrigerant circuit, each served by one expansion valve.



# period four

## Expansion Devices

### notes

### Refrigeration System Components

*period four*

### Expansion Devices

Figure 38

The final major component to be discussed is the expansion device.

### Expansion Device

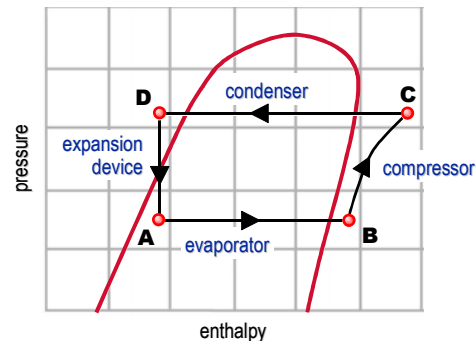

Figure 39

An **expansion device** is used to maintain a pressure difference between the high-pressure (condenser) and low-pressure (evaporator) sides of the system established by the compressor. This pressure difference allows the evaporator temperature to be low enough to absorb heat from the air or water to be cooled, while also allowing the refrigerant to be at a high enough temperature in the condenser to reject heat to air or water at normally available temperatures.

There are several types of expansion devices, including expansion valves (thermostatic or electronic), capillary tubes, and orifices. This clinic will limit its discussion to thermostatic expansion valves (TXVs). Other expansion devices perform essentially the same function.

## period four

# Expansion Devices

## notes

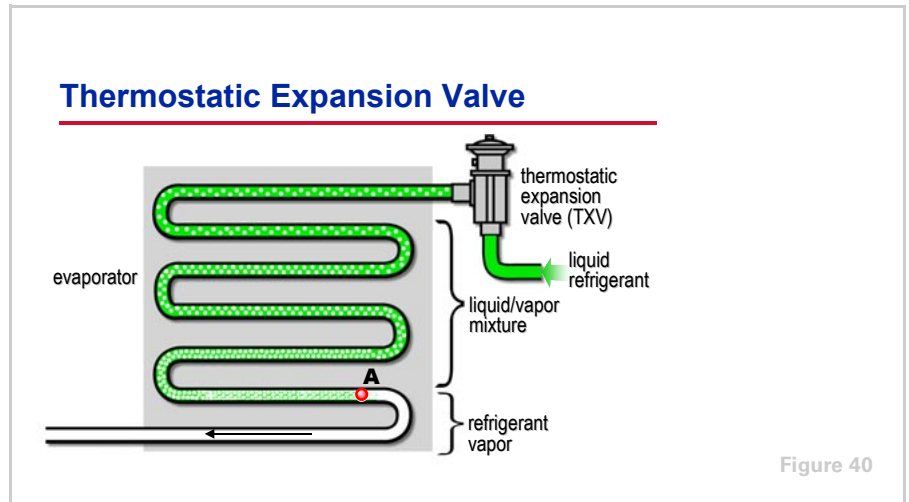

In addition to maintaining a pressure difference, the **thermostatic expansion valve** controls the quantity of liquid refrigerant entering the evaporator. It ensures that the refrigerant will be completely vaporized within the evaporator (**A**) and maintains the proper amount of superheat in the system.

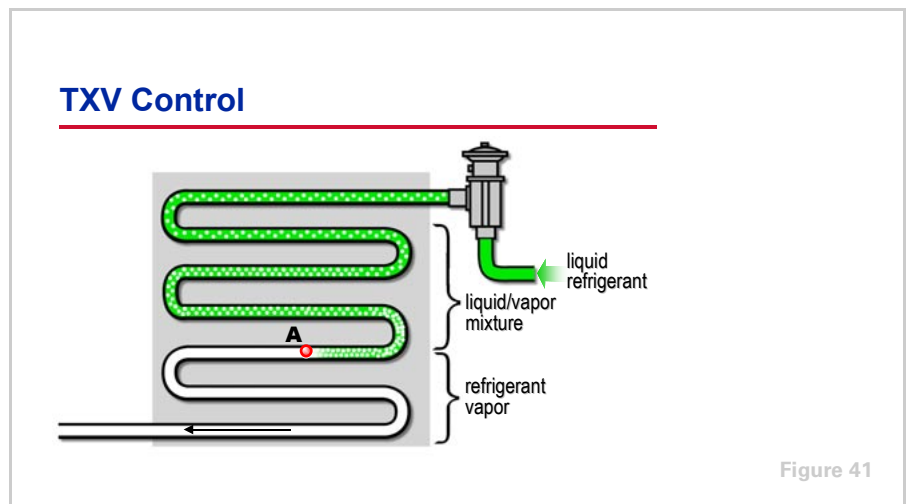

If not enough liquid refrigerant enters the evaporator, it vaporizes too quickly (**A**). As a result, the remaining coil tubes fill with vapor, producing very little refrigeration effect.

## period four

# Expansion Devices

### notes

#### TXV Control

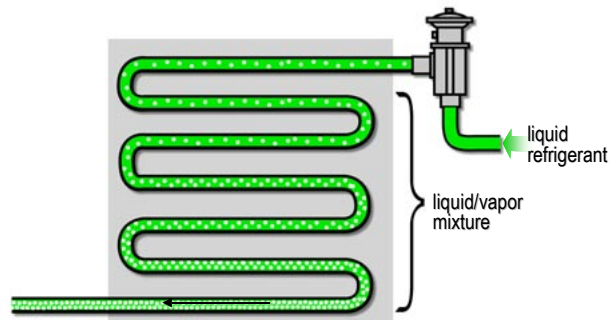

Figure 42

On the other hand, if too much liquid refrigerant enters the evaporator, not all of it will be vaporized. As a result, some liquid refrigerant gets into the compressor suction line. Since the compressor is designed to compress vapor and not liquid, liquid refrigerant can cause excess wear and damage to the compressor.

#### Superheat

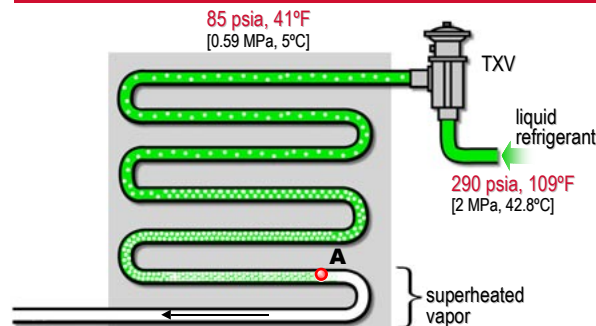

Figure 43

The TXV meters refrigerant by measuring the condition of the refrigerant vapor leaving the evaporator. **Superheat** is the additional heat absorbed by the refrigerant in the evaporator after it has completely vaporized. It provides a safety factor by preventing liquid refrigerant from entering the compressor.

In the example above, subcooled liquid refrigerant enters the TXV at a condensing pressure of 290 psia [2 MPa] and a temperature of 109°F [42.8°C]. (The refrigerant condensed at 124.3°F [51.3°C] and was subcooled to 109°F [42.8°C].) Passing through the TXV causes a large pressure drop, reducing the refrigerant pressure to that of the evaporator. This pressure drop causes a small

## period four

# Expansion Devices

### notes

portion of the liquid to boil off, or flash, and has the effect of cooling the remaining liquid refrigerant to the desired evaporator temperature. The resulting pressure of the refrigerant is 85 psia [0.59 MPa], which corresponds to 41°F [5°C].

Inside the evaporator tubes, as heat is transferred to the liquid refrigerant it boils until only vapor remains (**A**). From this point, the vapor continues to absorb heat as it passes through the final lengths of coil tubing, superheating the vapor.

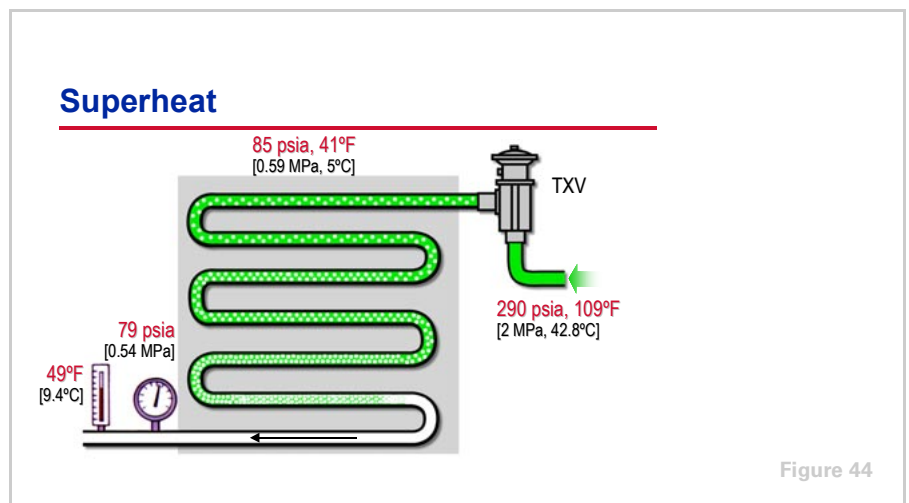

Continuing with this example, the refrigerant enters the evaporator coil at 85 psia [0.59 MPa] and 41°F [5°C]. Assuming that the pressure drop through the coil tubes is 6 psi [0.04 MPa], the refrigerant vapor leaves the coil at 79 psia [0.54 MPa]. The temperature gauge at the outlet of the evaporator coil indicates that the superheated refrigerant vapor leaves at 49°F [9.4°C].

A table of refrigerant properties, for Refrigerant-22 in this example, would show that the 79 psia [0.54 MPa] pressure corresponds to a 37°F [2.8°C] evaporating temperature. The 12°F [6.7°C] temperature difference between this evaporating temperature and the temperature measured at the outlet of the evaporator is the amount of additional heat, or superheat, absorbed by the refrigerant vapor in the final lengths of coil tubing. Notice that superheating the refrigerant vapor changed only its temperature—not its pressure.

These same properties—the evaporator pressure and the final refrigerant vapor temperature—are measured and used by the thermostatic expansion valve to control the quantity of liquid refrigerant entering the evaporator.

period four  
**Expansion Devices**

notes

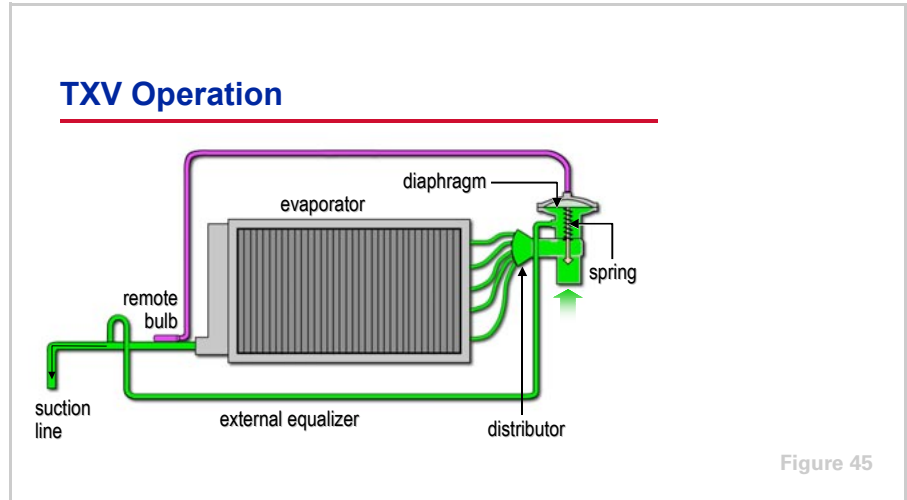

In a typical TXV application, the outlet of the valve is connected to the distributor. A remote bulb is attached to the suction line, where it senses the refrigerant vapor temperature leaving the evaporator. This bulb is charged with refrigerant and as heat is transferred from the suction line to the bulb, the refrigerant inside the bulb vaporizes. The resulting refrigerant vapor pressure is transmitted through a tube to the space above a diaphragm in the TXV.

The pressure of the refrigerant vapor leaving the evaporator is transmitted to the space beneath the diaphragm through an external equalizing line that is tapped into the suction line downstream of the bulb.

Finally, the valve contains an adjustable spring that applies a force to the lower side of the diaphragm.

## period four

# Expansion Devices

## notes

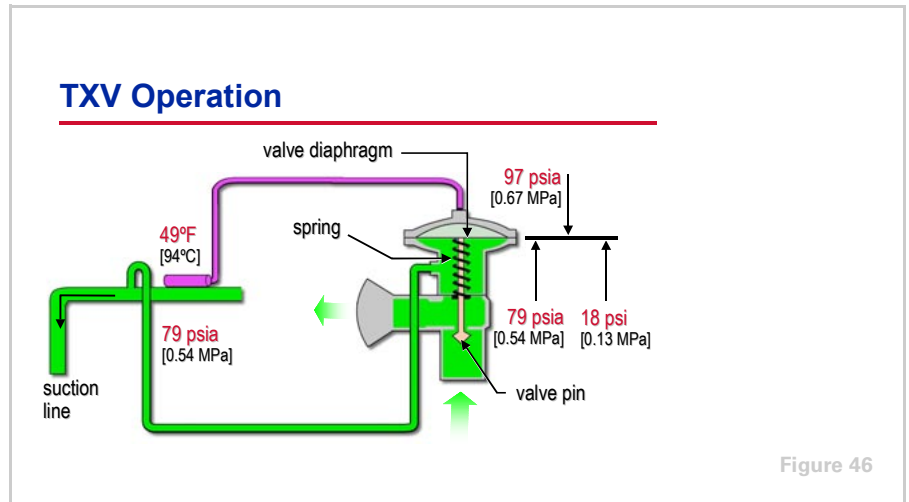

Using the conditions from the previous example, the 49°F [9.4°C] refrigerant vapor leaving the evaporator boils the refrigerant in the bulb, generating 97 psia [0.67 MPa] of pressure within the remote bulb. This pressure is transmitted to the top side of the valve diaphragm, creating a force that pushes down on the diaphragm.

The 79 psia [0.54 MPa] evaporating pressure, on the other hand, is transmitted to the bottom side of the valve diaphragm, producing an opposing force.

Since the difference between the evaporator pressure and the pressure within the remote bulb is due to superheat, the tension of the spring is adjusted to provide the difference in order to balance the forces and produce the desired amount of superheat. In this example, the spring tension is adjusted to produce an 18 psi [0.13 MPa] pressure difference, which corresponds to 12°F [6.7°C] of superheat.

Any variation in evaporator pressure causes these forces to vary from this equilibrium and move the pin up or down, thus closing or opening the valve. Closing the valve reduces the flow of refrigerant to the evaporator, while opening the valve increases the flow. In other words, with this valve spring adjustment, the refrigerant vapor must absorb 12°F [6.7°C] of superheat before the forces that open and close the valve come into equilibrium, stabilizing the refrigerant flow rate to the evaporator.

## period four

# Expansion Devices

## notes

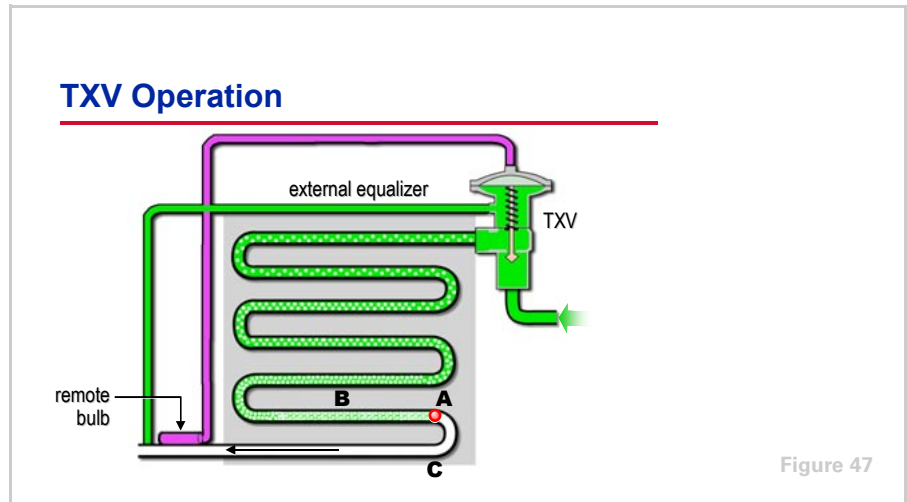

For example, assume that an increasing system load causes the refrigerant within the coil to vaporize at a faster rate than desired. This moves the point at which the refrigerant becomes completely vaporized from **A** toward **B**. This increase in coil surface used for superheating results in the refrigerant vapor leaving the evaporator at a higher temperature. Sensing the rising superheat, the remote bulb transmits a higher pressure to the top side of the TXV diaphragm, causing the valve to open further and allow more refrigerant to flow into the evaporator.

This increased flow of refrigerant moves the point of complete vaporization back toward **A**, until the desired superheat condition is reestablished and the opening and closing forces within the valve equalize at a refrigerant flow rate that balances the new system load.

Conversely, a decreasing system load slows the rate at which the refrigerant vaporizes, moving the point of complete vaporization toward **C**. The resulting reduction in superheat creates a lower pressure inside the remote bulb and, therefore, on the top side of the diaphragm. This causes the valve to close more, reducing the flow of liquid refrigerant into the evaporator. This reduction in refrigerant flow moves the point of complete vaporization back toward **A**, reestablishing the desired superheat condition.

## period four

# Expansion Devices

---

## notes

### Superheat Setting

---

- **Too little superheat:**
  - ◆ Risk of damage to compressor by liquid refrigerant
- **Too much superheat:**
  - ◆ Reduction of system efficiency
  - ◆ Potential of coil frosting
  - ◆ Risk of compressor damage due to overheating

Figure 48

A typical recommended superheat setting is from 8 to 12°F [4.4 to 6.7°C].

Too little superheat is risky because it presents a danger of allowing refrigerant to leave the evaporator in the liquid state. As mentioned earlier, the compressor is designed to compress vapor, not liquid. Liquid refrigerant can cause damage to the compressor.

Too much superheat dedicates too much of the tube surface to the production of superheat, reducing system efficiency. In extreme cases, it can lead to coil frosting; it may also cause the compressor to overheat, possibly shortening its service life.



## period five

# Accessories

---

### notes

### Refrigeration System Components

---

*period five*  
**Accessories**

Figure 49

This period discusses several accessories used in comfort-cooling refrigeration systems.

### Solenoid Valve

---

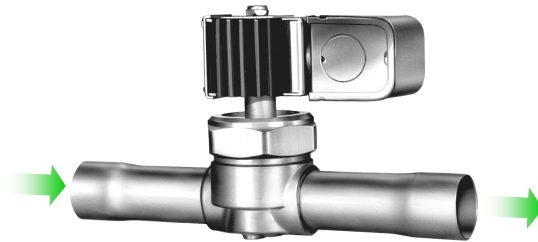

Figure 50

#### **Solenoid Valve**

A **solenoid valve** is used to stop the flow of refrigerant within the system. These valves are magnetically operated, and an electric winding controls the opening and closing of the valve. The valve is typically a normally-closed type of valve so that it is closed when it is deenergized.

## period five

# Accessories

## notes

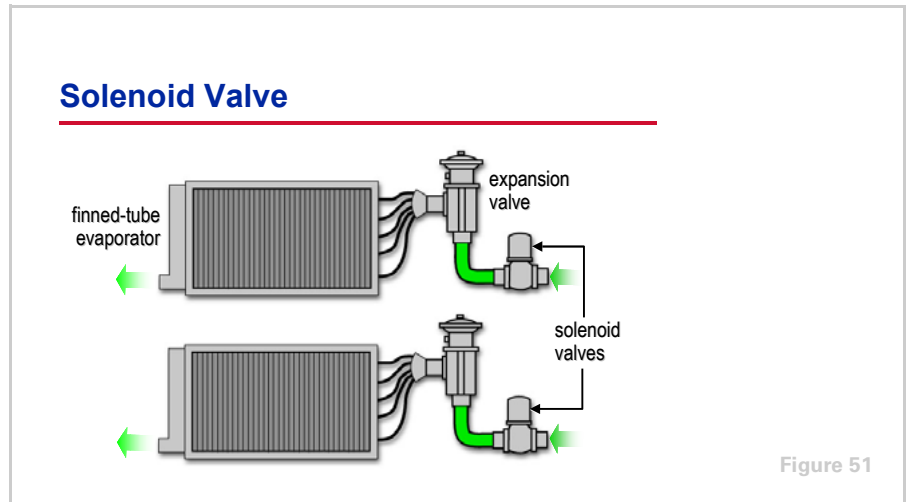

One common use of a solenoid valve is to control the flow of liquid refrigerant to multiple sections of the evaporator. In this application, a valve is installed in the liquid line, upstream of the expansion valve for each individually controlled section of the evaporator coil.

Using the example of a face-split evaporator coil, at lower loads a solenoid valve may be used to shut off the flow of liquid refrigerant to the top section of the coil. A portion of the air passes through the active lower section and is cooled, while the rest of the air passes through the inactive top section and remains unconditioned. The two airstreams mix downstream of the coil. At higher loads, both sections of the coil are activated.

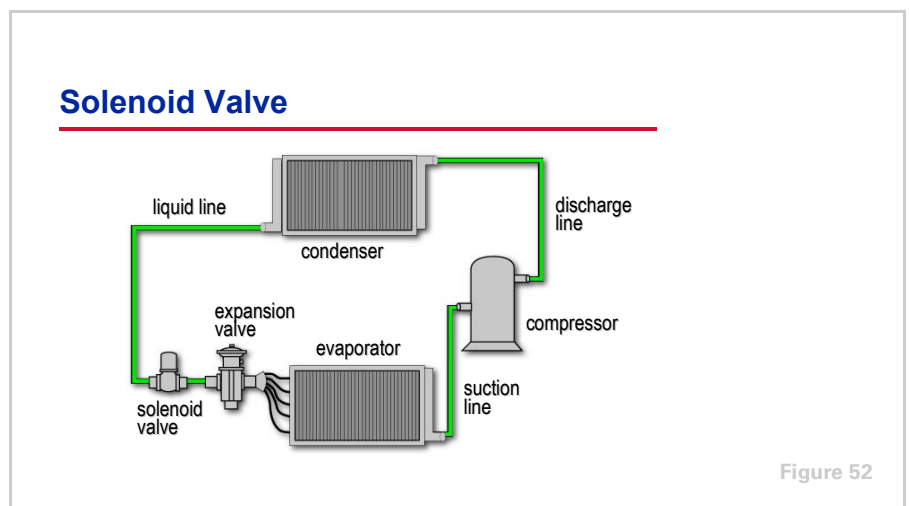

Another common use of a solenoid valve is to enable system pump-down and prevent the refrigerant from migrating through the system when the compressor is shut off. In this application, a single solenoid valve is installed in the liquid line, upstream of all expansion valves.

## period five

# Accessories

### notes

When the compressor is shut off, the evaporator contains a large quantity of liquid refrigerant. This can present a problem if some of the refrigerant drains into the suction line and slugs the compressor when it starts up again. To prevent this from occurring, many systems pump the refrigerant out of the evaporator and suction line before shutting the compressor off. This is called a **pump-down cycle**. Instead of shutting the compressor off right away, the solenoid valve is closed to stop the flow of liquid refrigerant into the evaporator, and the compressor is allowed to run for a short period of time. The compressor pumps the refrigerant from the low-pressure side of the system (evaporator and suction line) to the high-pressure side of the system (discharge line, condenser, and liquid line.)

As the low-pressure side of the system is pumped free of refrigerant, the pressure in that part of the system drops. To end the pump-down cycle, a pressure sensor is used to shut the compressor off when this pressure reaches a predetermined set point. Prior to starting the compressor again, the solenoid valve is opened, allowing the pressure on the low-pressure side of the system to increase again.

The solenoid valve should be installed as close to the expansion valve as possible. This will minimize the pump-down time and allow the liquid line to be used for storing refrigerant when the system is off.

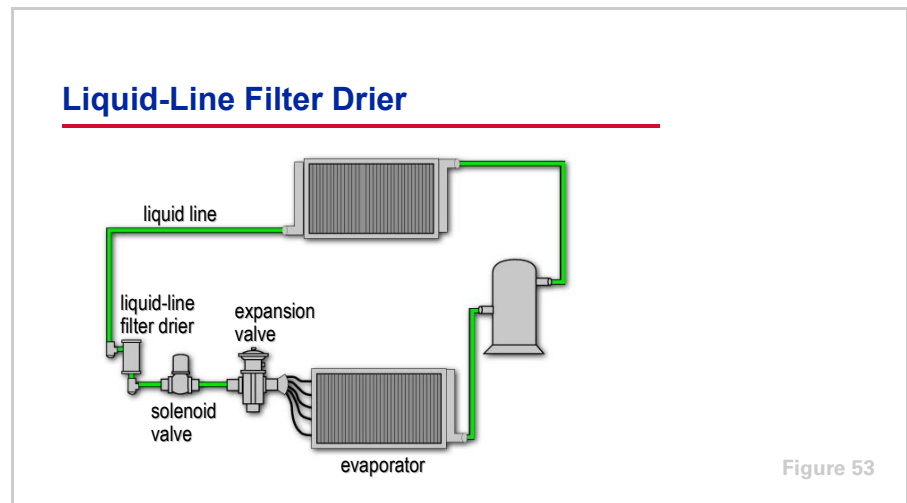

### Liquid-Line Filter Drier

The next accessory to be discussed, the **liquid-line filter drier**, is installed upstream of the solenoid valve and the expansion valve. It prevents moisture (water) and foreign matter, introduced during the installation process, from entering the expansion valve and the solenoid valve. Realize, however, that there is no substitute for cleanliness during system installation.

Moisture and foreign matter can cause problems in any refrigeration system. When water is mixed with refrigerant and oil, and heat is added by the compressor, acids are formed that can damage the valves or compressor. Additionally, certain foreign materials such as copper and brass particles can

## period five

# Accessories

### notes

act as a catalyst in chemical reactions that result in the formation of acids. These acids can corrode system components and cause the oil to sludge.

The filter drier should be installed close to the solenoid valve to provide the most protection for the solenoid and expansion valves.

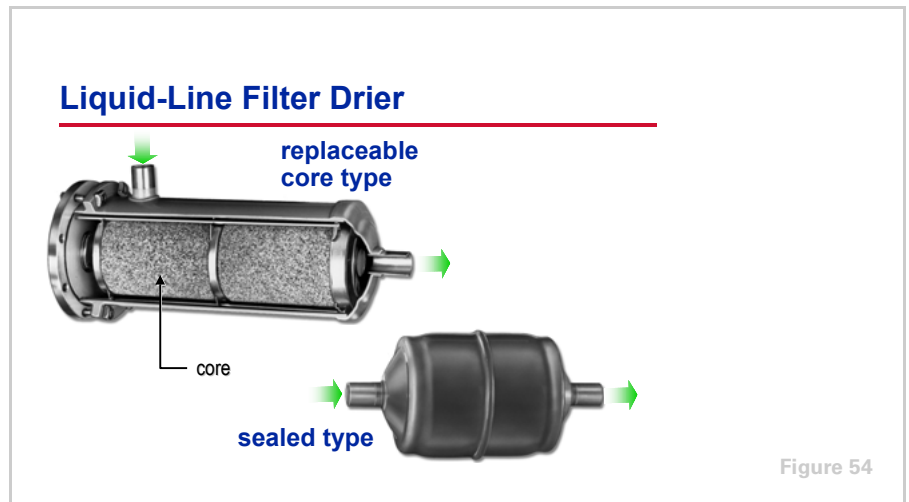

A typical liquid-line filter drier includes a molded, porous core. The core has a high affinity for moisture and removes foreign matter from the refrigerant.

The two common types of filter driers are replaceable core and sealed. The replaceable core type allows the core to be easily replaced. The sealed type is completely closed, reducing the chances of refrigerant leaks.

Ball-type shutoff valves are typically installed just upstream and downstream to allow the filter drier to be isolated and the core (or unit) replaced.

period five  
**Accessories**

notes

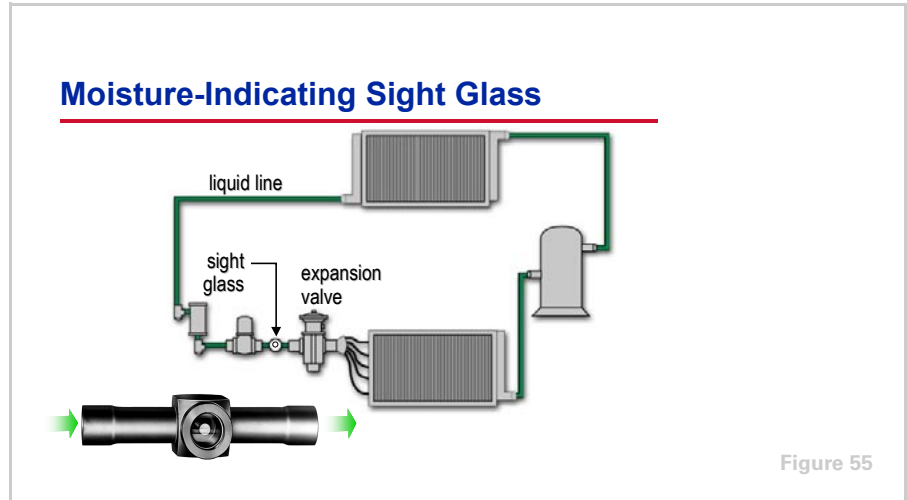

**Moisture-Indicating Sight Glass**

A **moisture-indicating sight glass** is installed in the liquid line, upstream of the expansion valve, and permits the operator to observe the condition of the refrigerant prior to entering the expansion valve. The value of the sight glass is in its moisture indication ability—the sight glass should not be used to determine system refrigerant charge or subcooling. Actual temperature and pressure measurements are required to determine proper charge and subcooling.

With the sight glass installed directly ahead of the expansion valve, it can also be used to detect the presence of bubbles in the liquid line. This would indicate that some of the liquid refrigerant has flashed into vapor upstream of the expansion valve. Since the expansion valve is designed to control the flow of liquid refrigerant only, the presence of refrigerant vapor results in a reduction in the quantity of liquid refrigerant being fed to the evaporator. There are many potential causes of liquid refrigerant flashing. The sight glass can alert the operator to the condition.

## period five

# Accessories

## notes

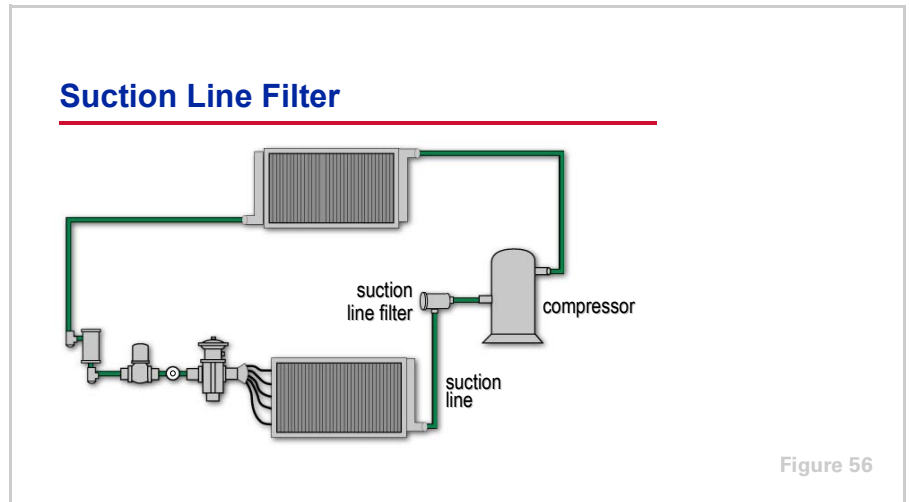

### Suction Line Filter

Similar to the liquid-line filter drier, the **suction line filter** performs the task of removing foreign matter from the refrigeration system. It is installed in the suction line, just upstream of the compressor.

The suction filter contains filter media to remove copper filings, flux, dirt, and other foreign matter that may have been introduced during the installation process or as the result of a compressor failure. It protects the compressor parts from the abrasive action that could result if these materials enter the compressor. Dirt can obstruct oil passages, robbing the compressor bearings of lubrication.

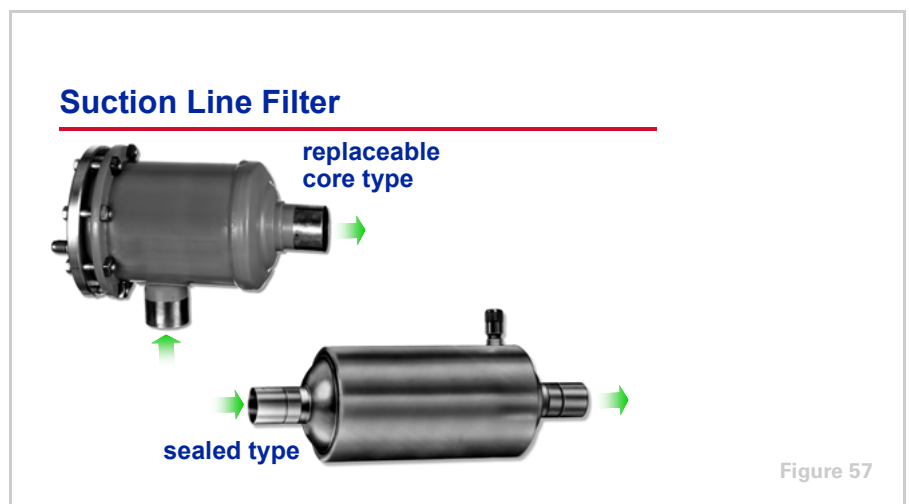

Similar to the liquid-line filter drier, the two common types of suction line filters are replaceable core and sealed. The replaceable core type allows the core to be easily replaced. The sealed type is completely closed, reducing the chances of refrigerant leaks.

## period five

# Accessories

### notes

Replaceable core suction filters are commonly installed after a compressor failure has occurred. The core is replaced after the foreign matter or acid has been removed from the system.

Additionally, suction filters should be installed in all field-assembled systems.

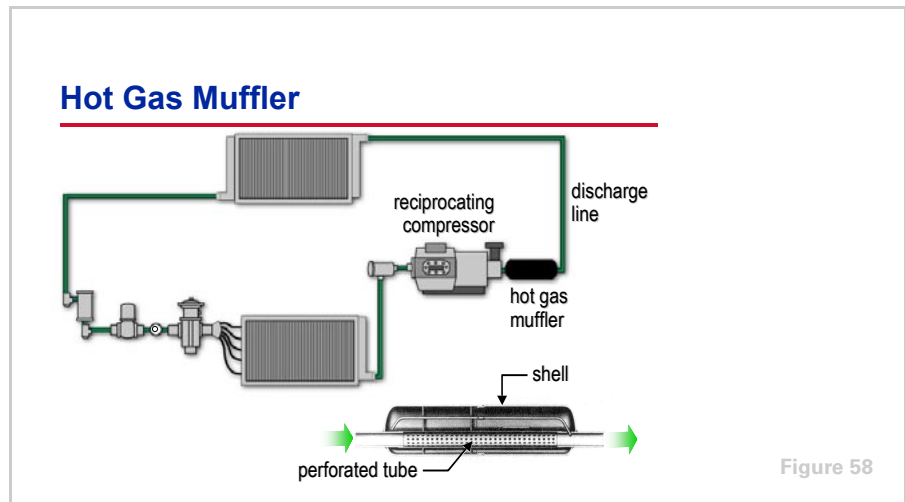

### Hot Gas Muffler

The purpose of the **hot gas muffler** is to smooth out the pulsations associated with the refrigerant vapor being discharged from a reciprocating compressor, reducing noise and vibration.

The pressure of the refrigerant vapor leaving a reciprocating compressor fluctuates rapidly because of the manner in which it is compressed by the reciprocating pistons. The muffler contains a perforated tube inside a shell. The pressure peaks cause some of the refrigerant vapor to pass from the perforated tube into the muffler shell. This shell is divided into chambers that allow it to absorb these peaks. In essence, the muffler shaves off the peaks of these pulsations and fills in the valleys, reducing the pulsating characteristic in the discharge line.

When used, the hot gas muffler should be located in the discharge line, as close to the reciprocating compressor discharge as possible. This minimizes the sound emission from the unmuffled section of discharge line.

## period five

# Accessories

## notes

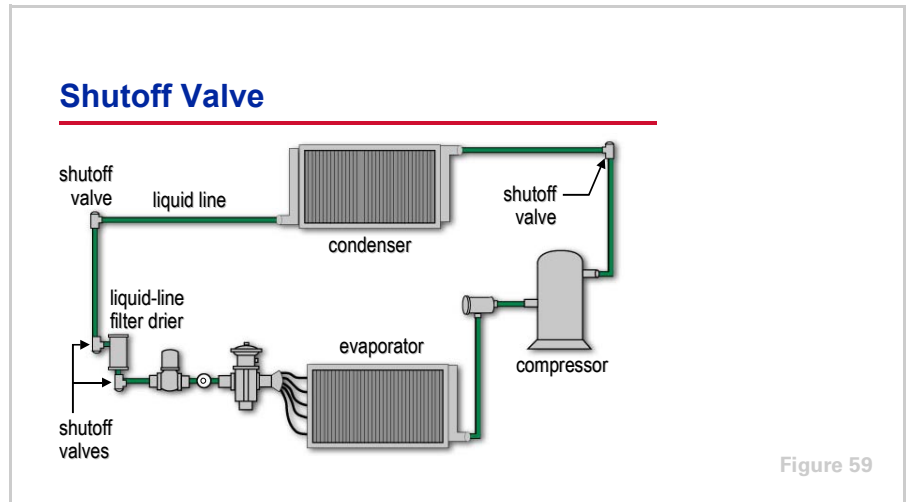

### Shutoff Valve

**Shutoff valves** are used to isolate one part of the refrigeration system from the rest. Additionally, they can be used to trap the refrigerant charge in one component of the system, the condenser for example, to permit service or repair to another part of the system.

Common uses of shutoff valves include:

- Isolating the liquid-line filter drier and suction filter to allow easier core (or unit) replacement
- Isolating the compressor from the rest of the system to allow for repair or replacement
- Isolating the charge within the condenser or a receiver to allow access to the rest of the system



period five  
**Accessories**

---

notes

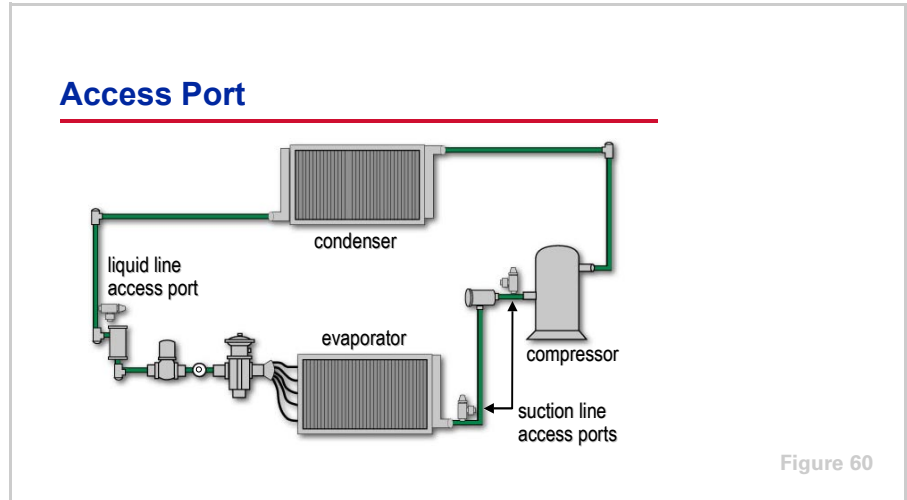

**Access Port**

An **access port** is used to add refrigerant to the system or for measurement. An access port is typically installed in the liquid line in a convenient location and is used to charge the system with liquid refrigerant. It is also used to measure subcooling.

The suction line typically includes two access ports. One is installed near the compressor and is used to measure suction pressure. The other is located near the external equalizer-line connection for the expansion valve, and is used to measure superheat when checking or adjusting the expansion valve setting.

# period six

## Review

### notes

### Refrigeration System Components

*period six*  
Review

Figure 61

We will now review the main concepts that were covered in this clinic about the components in a vapor-compression refrigeration system.

### Review—Period One

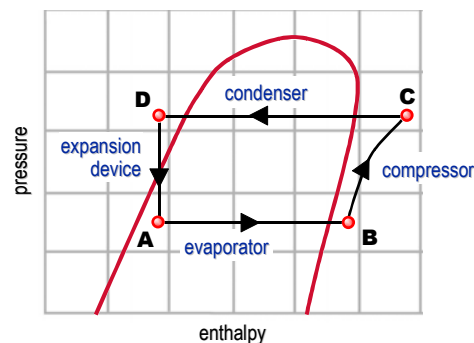

Figure 62

Period One reviewed the vapor-compression refrigeration cycle using the P-h chart.

A cool, low-pressure mixture of liquid and vapor refrigerant enters the evaporator (**A**) and absorbs heat from the relatively warm air or water that is being cooled. This transfer of heat boils the liquid refrigerant in the evaporator and superheated refrigerant vapor (**B**) is drawn to the compressor.

The compressor raises the pressure and temperature (**C**) high enough that the refrigerant vapor can reject heat to another fluid. This hot, high-pressure refrigerant vapor then travels to the condenser where heat is transferred to relatively cool ambient air or cooling water. This reduction in the heat content

## period six Review

---

### notes

of the refrigerant vapor causes it to desuperheat, condense into liquid, and further subcool before leaving the condenser (**D**) for the expansion device.

Finally, the high-pressure liquid refrigerant flows through the expansion device, causing a large pressure drop (the line from **D** to **A**) that reduces the pressure of the refrigerant to that of the evaporator. This pressure reduction causes a small portion of the liquid to boil off, or flash, cooling the remaining refrigerant to the desired evaporator temperature. The cooled refrigerant then enters the evaporator (**A**) to repeat the cycle.

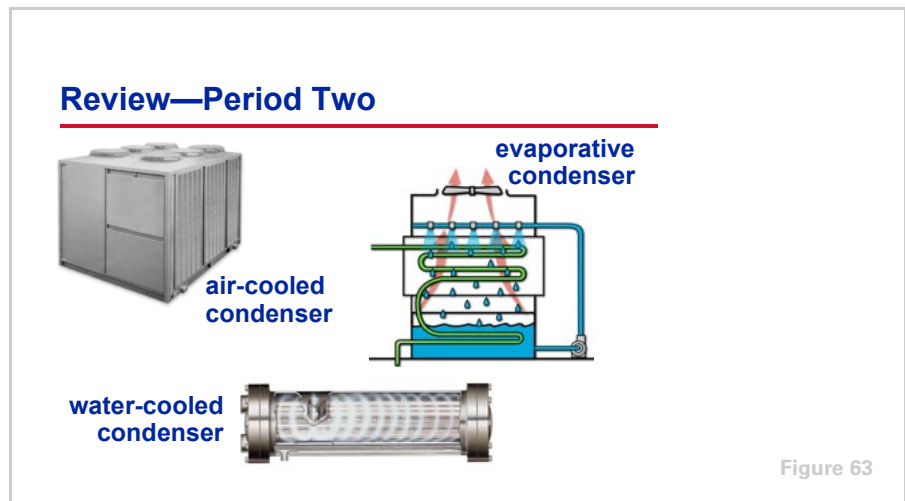

Period Two discussed the different types of condensers and methods of condenser control. The condenser rejects heat from the refrigerant to air, water, or some other fluid. The three common types of condensers are air-cooled, water-cooled, and evaporative.

## period six

# Review

## notes

### Review—Period Three

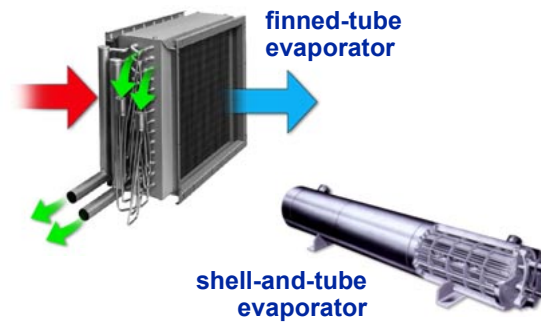

Figure 64

Period Three presented the different types of evaporators and methods of evaporator control. The evaporator transfers heat from air, water, or some other fluid to the cool liquid refrigerant. The two common types of evaporators are finned-tube and shell-and-tube.

### Review—Period Four

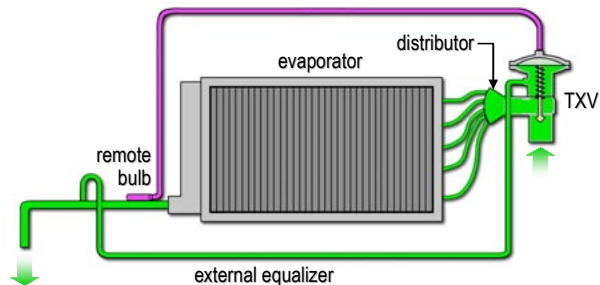

Figure 65

Period Four reviewed the operation of the expansion device, specifically the thermostatic expansion valve. The expansion device is used to maintain the pressure difference between the high-pressure (condenser) and low-pressure (evaporator) sides of the system established by the compressor.

In addition, the thermostatic expansion valve (TXV) controls the quantity of liquid refrigerant entering the evaporator. It ensures that the refrigerant will be completely vaporized within the evaporator and maintains the proper amount of superheat in the system.

## period six

# Review

## notes

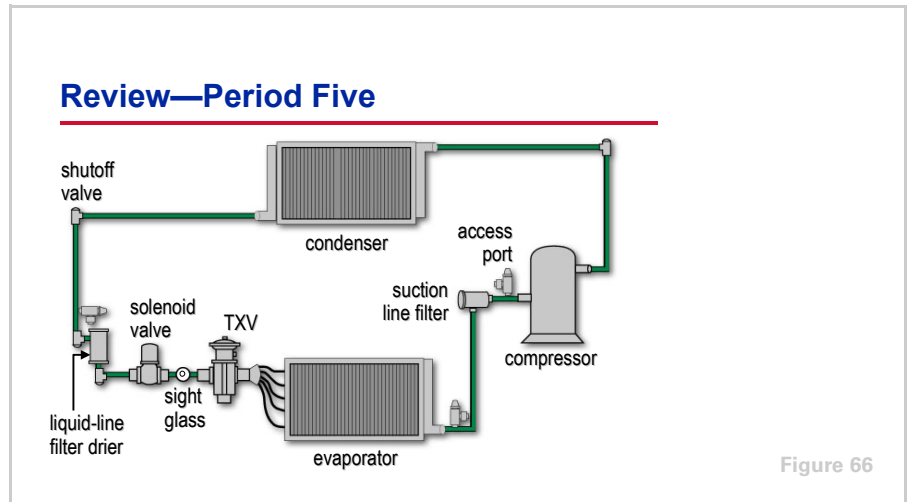

Period Five discussed several accessories commonly used in comfort-cooling applications, including: solenoid valve, liquid-line filter drier, moisture-indicating sight glass, suction line filter, hot gas muffler, shutoff valve, and access port.

The solenoid valve is used to stop the flow of refrigerant within the system. A liquid-line filter drier prevents moisture and foreign matter from damaging the valves or compressor. The moisture-indicating sight glass permits the operator to observe the condition of the refrigerant within the liquid line before it enters the expansion device. A suction line filter protects the compressor from foreign matter in the suction line. The hot gas muffler is used to reduce noise and vibration associated with reciprocating compressors. Shutoff valves are used to isolate one part of the refrigeration system, and access ports allow a technician to gain access to the system for charging or measurement.

## period six **Review**

---

### notes



For more information, refer to the following references:

- *Trane Air Conditioning Manual*
- *Trane Reciprocating Refrigeration Manual*
- "The DX Refrigerant Cooling Coil Conundrum" (*Trane Engineers Newsletter*, 1988 volume 17, number 1)
- *ASHRAE Handbook – Fundamentals*
- *ASHRAE Handbook – Refrigeration*
- *ASHRAE Handbook – Systems and Equipment*

Visit the ASHRAE Bookstore at [www.ashrae.org](http://www.ashrae.org).

For more information on additional educational materials available from Trane, contact your local Trane office (request a copy of the Educational Materials catalog –Trane order number EM-ADV1) or visit our online bookstore at [www.trane.com/bookstore/](http://www.trane.com/bookstore/).

# Quiz

## Questions for Period 1

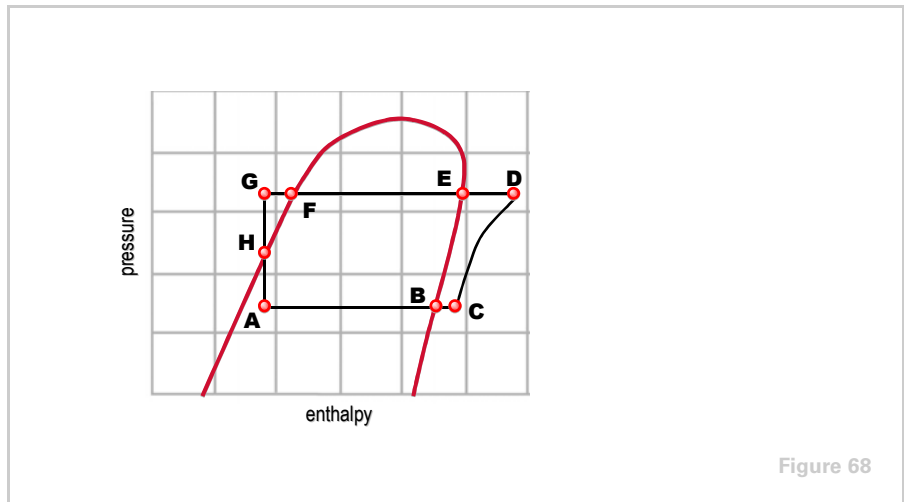

Figure 68

- 1 Using the pressure–enthalpy chart in Figure 68, which two points correspond to superheating the refrigerant vapor inside the evaporator?
- 2 Again using Figure 68, which two points correspond to subcooling the liquid refrigerant inside the condenser?

## Questions for Period 2

- 3 List the three common types of condensers.
- 4 What two factors cause the condensing pressure to drop?
- 5 What are two methods of control that can be applied to air-cooled condensers?

## Questions for Period 3

- 6 What is the name of the device used to ensure uniform refrigerant distribution through the multiple-coil circuits of a finned-tube evaporator?
- 7 What is the purpose of the baffles inside the shell-and-tube evaporator?
- 8 What are the three common arrangements for splitting finned-tube evaporator coils?
- 9 When using a face-split coil in a constant-volume application, which section (top or bottom) of the coil should be activated first and deactivated last?

# Quiz

---

## Questions for Period 4

- 10** What are the two primary purposes of a thermostatic expansion valve?
- 11** What are the risks of too much superheat in the system?

## Questions for Period 5

- 12** During a pump-down cycle, the compressor pumps the refrigerant from the \_\_\_\_ (low or high)-pressure side of the system to the \_\_\_\_ (low or high)-pressure side.
- 13** Is the moisture-indicating sight glass installed upstream or downstream of the expansion valve?



## Answers

---

- 1 B to C**
- 2 F to G**
- 3** Air-cooled, evaporative, and water-cooled
- 4** A decrease in system load and a reduction in the outdoor air temperature
- 5** Varying the airflow through the condenser coil or flooding the condenser coil with liquid refrigerant
- 6** A distributor
- 7** To direct the water in a rising and falling flow path over the tubes that carry the refrigerant; resulting in turbulence that improves heat transfer
- 8** Face-split, intertwined, and row-split
- 9** Bottom section
- 10** The thermostatic expansion valve a) maintains the pressure difference between the high-pressure and low-pressure sides of the system, and b) maintains the proper amount of superheat in the system by metering the quantity of liquid refrigerant entering the evaporator, ensuring it will be completely vaporized within the evaporator.
- 11** Too much superheat dedicates too much of the tube surface to the production of superheat, reducing system efficiency. In extreme cases, it can lead to coil frosting and overheating of the compressor, compromising its longevity.
- 12** Low-pressure side to the high-pressure side
- 13** Upstream of the expansion valve

# Glossary

---

**access port** A device that allows a technician to gain access to the refrigeration system for charging or measurement.

**air-cooled condenser** A type of condenser where refrigerant flows through the tubes and rejects heat to air that is drawn across the tubes.

**ASHRAE** American Society of Heating, Refrigerating and Air-Conditioning Engineers

**capillary tube** A type of expansion device that uses a long, narrow tube to reduce the pressure and temperature of the refrigerant.

**centrifugal fan air-cooled condenser** A type of air-cooled condenser that uses a centrifugal fan instead of a propeller fan, allowing it to overcome the larger static pressures associated with ductwork.

**compressor** The mechanical device in the refrigeration system used to increase the pressure and temperature of the refrigerant vapor.

**condenser** The component of the refrigeration system where refrigerant vapor is converted to liquid as it rejects heat to water or air.

**cooling tower** A device used to reject the heat from a water-cooled condenser by spraying the condensing water over the fill while drawing outdoor air upward through the fill.

**distributor** A device used to ensure uniform refrigerant distribution through the multiple-coil circuits of a finned-tube evaporator.

**electronic expansion valve** A type of expansion device that uses an electronically-actuated valve to sense and control the flow rate of liquid refrigerant to the evaporator.

**enthalpy** The property of a refrigerant indicating its heat content, both sensible and latent, per pound [kg] of refrigerant.

**evaporative condenser** A type of condenser where refrigerant flows through the tubes and rejects heat to air. The air is drawn across the tubes, which are wetted on the outside by circulating water.

**evaporator** The component of the refrigeration system where cool liquid refrigerant absorbs heat from air, water, or some other fluid, causing the refrigerant to boil.

**expansion device** The component of the refrigeration system used to reduce the pressure and temperature of the refrigerant.

**expansion valve** The type of expansion device that maintains the pressure difference between the high-pressure and low-pressure sides of the system. It also maintains the proper amount of superheat in the system by metering the quantity of liquid refrigerant entering the evaporator, ensuring that the refrigerant will be completely vaporized within the evaporator

# Glossary

---

**face-split** A type of finned-tube evaporator arrangement that splits the coil into parallel air paths.

**fill** The heat transfer surface inside a cooling tower.

**finned-tube evaporator** A type of evaporator where refrigerant flows through the tubes and air blows across the tubes and fins.

**flash** The process of liquid refrigerant being vaporized by a sudden reduction of pressure.

**hot gas muffler** A device installed at the discharge of the compressor to reduce noise and vibration associated with reciprocating compressors.

**intertwined** A type of finned-tube evaporator arrangement that splits the coil by alternating the tubes fed in each row between two distributors.

**liquid-line filter drier** A device installed in the liquid line to remove moisture (water) and foreign matter, introduced during the installation process, from the refrigeration system.

**moisture-indicating sight glass** See sight glass, moisture indicating.

**orifice plate** A type of expansion device that uses a fixed plate with holes drilled in it to reduce the pressure and temperature of the refrigerant.

**pressure–enthalpy chart** A graphical representation of the saturated properties of a refrigerant, plotting refrigerant pressure versus enthalpy.

**pump-down cycle** A control sequence used in a refrigeration system to pump the refrigerant from the low-pressure side of the system to the high-pressure side of the system.

**refrigeration effect** The amount of heat that each pound [kg] of liquid refrigerant will absorb when it evaporates.

**row-split** A type of finned-tube evaporator arrangement that splits the coil by placing the independently-controlled coil sections in series in the airstream.

**shell-and-tube evaporator** A type of evaporator where refrigerant flows through the tubes and water fills the surrounding shell.

**shutoff valve** Devices used to isolate one part of the refrigeration system from the rest.

**sight glass, moisture-indicating** A device installed in the liquid line, upstream of the expansion valve, used to detect moisture in the system and determine if the liquid refrigerant has flashed into vapor before entering the expansion valve.

**solenoid valve** A device used to stop the flow of refrigerant within the refrigeration system.

# Glossary

---

**subcooler** The lower portion of the condenser that further cools the saturated liquid refrigerant.

**suction header** A section of pipe used to collect the refrigerant vapor when it leaves the tubes of a finned-tube evaporator coil.

**suction line filter** A device installed in the suction line to remove foreign matter from the refrigeration system.

**superheat** The amount of heat added to the refrigerant vapor after it has completely vaporized within the evaporator.

**thermostatic expansion valve** A type of expansion device that uses a thermally-actuated valve to sense and control the flow rate of liquid refrigerant to the evaporator.

**water-cooled condenser** A type of condenser where water flows through the tubes and absorbs heat from the refrigerant that fills the surrounding shell.



**TRANE®**

**The Trane Company**  
Worldwide Applied Systems Group  
3600 Pammel Creek Road  
La Crosse, WI 54601-7599  
[www.trane.com](http://www.trane.com)

An American Standard Company

---

Literature Order Number TRG-TRC005-EN

---

File Number E/AV-FND-TRG-TRC005-1199-EN

---

Supersedes 2803-3-784 and 2803-5-1284

---

Stocking Location Inland-La Crosse

---

Since The Trane Company has a policy of continuous product improvement, it reserves the right to change design and specifications without notice.